



auto brake



Bertocco

ÜRÜN KATALOĞU

Product Catalogue

www.autobrake.com.tr

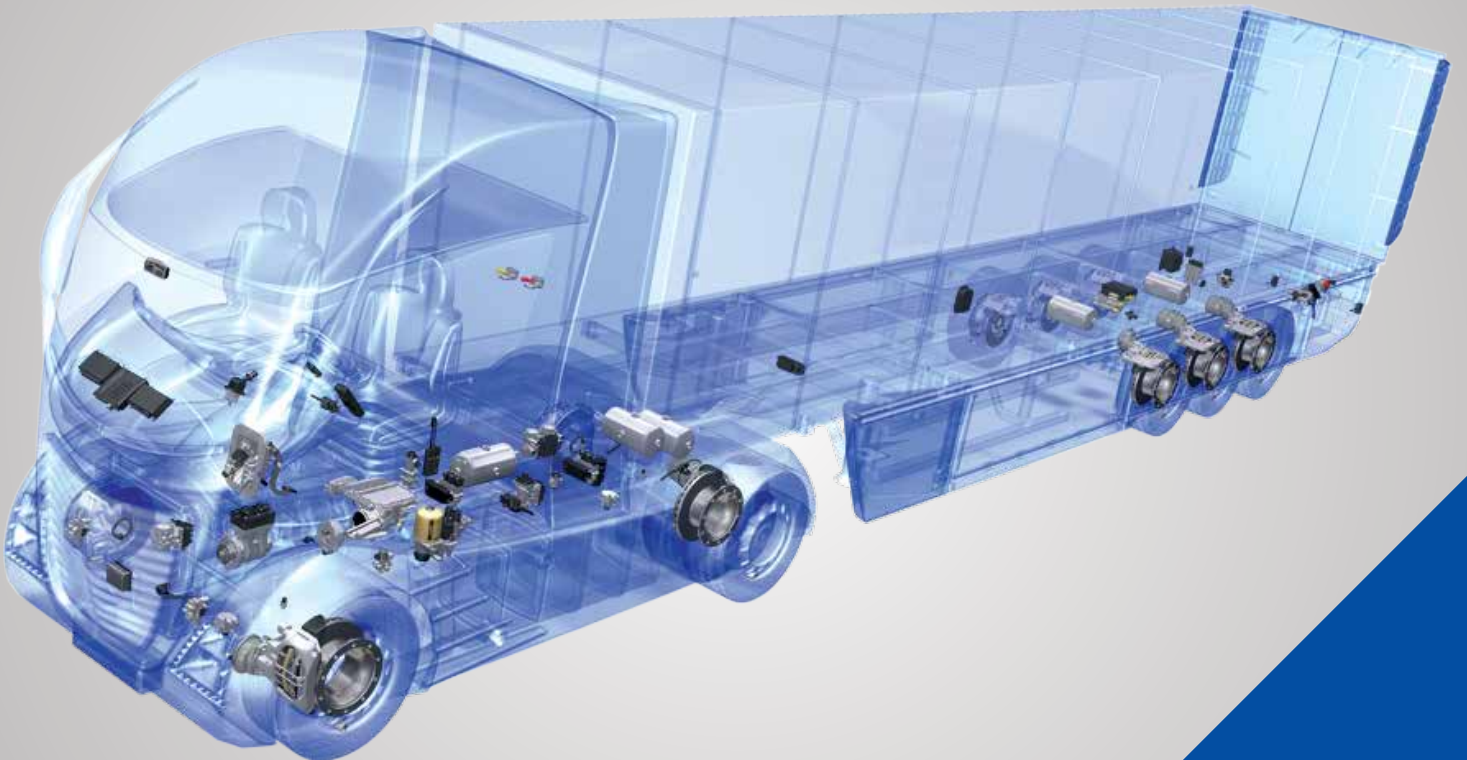

İÇİNDEKİLER

Hava Tahliyeler	2
Kurutucu Tahliyeler	3-4
Altılı Dağıtıcı Ventiller	5
Çabuk Tahliyeler	6
Fren Pedal Merkezleri	7
Role Ventiller	8-9
Dörtlü Dağıtıcılar	10-11
Dorse Kumanda Ventilleri	12-13
Yük Ayar Ventilleri	14
Basınç Ayar Valfleri	15-16
Kasa Körük Ventilleri	17-18
Şanzuman Ventilleri	19-20
Muhtelif Ventiller	21-22
Kabin Seviye Ventilleri	23
El Fren Kolları	24-26
Debriyaj Merkezleri	27-31
Fren Körükleri	32-33
Disk Fren Körükleri	34
Fren Diyafram Lastikleri	35
Ecas Sensör Ventilleri	38
Selenoid Valfler	39
Abs Sensörleri	40-43
Balata Sensörleri	44-45
Dorse Malzemeleri	48-49
Polyemit Hortumlar	50
Knorr Tipi Kaliper Grubu	51-59
Wabco Tipi Kaliper Grubu	60-64
Bpw Tipi Kaliper Grubu	65-66
Meritor Tipi Kaliper Grubu	67-71
Haldex Tipi Kaliper Grubu	72-73
Kamalı Fren Parçaları	74
Saks Fren Yedek Parçaları	75-76
Yaylar	77-79
Abs Çemberleri	80-81
Akson Dingil Somunları	82-83
Porya Kapaklar	84-86

PNÖMATİK TEST TEZGAHI

TM-01

1. PNÖMATİK OLARAK VENTİL - VALF GURUBU BASINÇ VE KAÇAK TESTLERİ YAPABİLİR.
2. ELEKTRONİK BOBİNLERİ ARIZA KONTROLÜ YAPABİLİR.
3. EBS BEYİNLERİNİ KONTROL EDEBİLMEK İÇİN HARİCİ CİHAZ BAĞLAYABİLECEĞİNİZ SOKETLER VE FİŞLER HAZIRDIR.





ŞİŞİRİCİLİ 8, 1 BAR

HAVA TAHLİYE

RH 101.00

Referans No:975 303 473 0



BMC - DODGE

SU TAHLİYE

RH 102.00

Referans No:434 300 000 0



BMC - DODGE

GİZLİ TAHLİYE

RH 109.00

Referans No: 275508



MERCEDES O403

SU TAHLİYE

RH 150.00

Referans No: 352 900 300 10



MERCEDES 403
ELEKTRİKLİ BÖLÜM

SU TAHLİYE

RH 150.01

Referans No: 352 900 300 10



IVECO / 10,5 BAR / FİLTRESİZ

KURUTUCULU TAHLİYERH 113.10
Referans No: LA 8125

IVECO STRALIS / 10,5 BAR / FİLTRESİZ

KURUTUCULU TAHLİYERH 113.15
Referans No: LA 8606

IVECO / 12,5 BAR / FİLTRESİZ

KURUTUCULU TAHLİYERH 113.21
Referans No: LA 8222

DAF XF 95 / 8,1 BAR / FİLTRESİZ

KURUTUCULU TAHLİYERH 113.24
Referans No: LA 8225 (LA 6252)

MAN / 12,5 BAR / FİLTRESİZ

KURUTUCULU TAHLİYERH 113.72
Referans No: LA 8210MERCEDES AXOR 4140
12,5 BAR / FİLTRESİZ**KURUTUCULU TAHLİYE**RH 114.00
Referans No: LA 9010-9034BMC / MERCEDES 2521
8,1 BAR / FİLTRESİZ**KURUTUCULU TAHLİYE**RH 120.06
Referans No:432 410 102 0MUHTELİF ARAÇLAR
12,5 BAR / FİLTRESİZ**KURUTUCULU TAHLİYE**RH 120.14
Referans No:432 410 004 0MERCEDES AXOR / 12,5 BAR
FİLTRESİZ**KURUTUCULU TAHLİYE**RH 120.50
Referans No: 932 400 024 0



FORD CARGO 3230 / FİLTRESİZ

KURUTUCULU TAHLİYE

RH 120.60

Referans No: 432 415 022 0



IVECO / 12,5 BAR / FİLTRESİZ

KURUTUCULU TAHLİYE

RH 120.70

Referans No: 432 410 034 0



SCANIA 3/4 FİLTRESİZ

KURUTUCULU TAHLİYE

RH 120.93

Referans No: 432 410 083 0



DAF / FİLTRESİZ

KURUTUCULU TAHLİYE

RH 128.00

Referans No: LA 8130



VOLVO FH-FM / FİLTRESİZ

KURUTUCULU TAHLİYE

RH 129.00

Referans No: 432 425 101 0



RENAULT / 12,5 BAR / FİLTRESİZ

KURUTUCULU TAHLİYE

RH 133.21

Referans No: LA 8053



FORD CARGO 1838 / FİLTRESİZ

KURUTUCULU TAHLİYE

RH 135.00

Referans No: ZB 4424



MERCEDES AXOR
MÜŞÜRLÜ

ALTILI DAĞITICI VENTİL

RH 111.00
Referans No: 934 705 005 0



MERCEDES AXOR
MÜŞÜRSÜZ

ALTILI DAĞITICI VENTİL

RH 111.01
Referans No:975 303 473 0



WABCO TIPI

ALTILI DAĞITICI MÜŞÜR

RH 111.02
Referans No: 441 043 001 0



WABCO TIPI

ALTILI DAĞITICI MÜŞÜR

RH 111.03
Referans No: 932 500 501 1



5 VOLT KNORR TIPI

ALTILI DAĞITICI MÜŞÜR

RH 111.04
Referans No: II39746F004



DAF

ALTILI DAĞITICI VENTİL

RH 115.03
Referans No: AE 4528



IVECO STRALIS

ALTILI DAĞITICI VENTİL

RH 115.60
Referans No: AE 4560



MERCEDES AXOR 4140

ALTILI DAĞITICI VENTİL

RH 141.00
Referans No:AE 4800



M22 x 1,5 Diş

ÇABUK TAHLİYE VALFİ

RH 118.00

Referans No: 973 500 000 0



FORD CARGO
1/2 - 3/8

ÇABUK TAHLİYE VALFİ

RH 118.01

Referans No: 973 500 014 0



1/4 Diş

ÇABUK TAHLİYE VALFİ

RH 118.02

Referans No: 5050007



M16 x 1,5 Diş

ÇABUK TAHLİYE VALFİ

RH 118.03

Referans No: 973 500 006 0



1 GİRİŞ M22 x 1,5 Diş
2 ÇIKIŞ M16 x 1,5 Diş

ÇABUK TAHLİYE VALFİ

RH 118.04

Referans No:



M22 x 1,5 Diş

AYARLI ÇABUK TAHLİYE VALFİ

RH 118.05

Referans No: 975 001 000 0



MUHTELİF ARAÇLAR
8 DELİK = M16*1,5

FREN PEDAL VALFİ

RH 201.00
Referans No: 461 315 008 0



MUHTELİF ARAÇLAR
10 DELİK - 8 = M16*1,5 / 2 = M12*1,5

FREN PEDAL VALFİ

RH 201.01
Referans No: 461 315 042 0



FORD CARGO

FREN PEDAL VALFİ

RH 216.00
Referans No: APGA 6620



MAN

FREN PEDAL VALFİ

RH 224.00
Referans No: MB 4820



SCANIA

FREN PEDAL VALFİ

RH 225.00
Referans No: 481 064 603 0 - 1324664



MERCEDES AXOR

FREN PEDAL VALFİ

RH 240.16
Referans No: 461 319 274 0



IVECO

FREN PEDAL VALFİ

RH 250.00
Referans No:DX 75 BAY



IVECO

FREN PEDAL VALFİ

RH 250.01
Referans No: DX 95 B



FREN PEDAL MÜŞÜRÜ

RH 290.00
Referans No: 441 044 1010



M16*1,5

ROLE VENTİL

RH 301-00

Referans No: 973 001 020 0



M22*1,5

ROLE VENTİL

RH 301-01

Referans No: 973 001 010 0



M22*1,5 / 5 DELİK

ROLE VENTİL

RH 303-00

Referans No: 473 017 000 0



M22*1,5

ROLE VENTİL

RH 306-00

Referans No: 973 011 000 0



M22*1,5

ROLE VENTİL

RH 306.20

Referans No: 973 011 200 0



M22*1,5

ROLE VENTİL

RH 306.21

Referans No: 973 011 201 0



M22*1,5

ROLE VENTİL

RH 306.25

Referans No: 973 011 206 0



M22*1,5

ROLE VENTİL

RH 306.30

Referans No: 973 011 050 0



M22*1,5

ROLE VENTİL

RH 306.51

Referans No: 973 006 003 0
MERCEDES : 004 429 634 4



M22*1,5

ROLE VENTİL

RH 308.00

Referans No: AC 577A



M22*1,5

ROLE VENTİL

RH 329.00

Referans No: AC 574 AX Y



MAN - MERCEDES

ROLE VENTİL

RH 426.16

Referans No: 480 205 106 0



1 =M22*1,5 - 4 =M16*1,5

DÖRTLÜ DAĞITICI VENTİL

RH 312.06

Referans No: 934 702 300 0



7 YOLLU M16*1,5

DÖRTLÜ DAĞITICI VENTİL

RH 313.01

Referans No: 934 702 210 0



M22*1,5

DÖRTLÜ DAĞITICI VENTİL

RH 313.10

Referans No: 934 702 206 0



7 YOLLU
1 = M22*1,5 - 6 = M16*1,5 / 10 BAR

DÖRTLÜ DAĞITICI VENTİL

RH 319.00

Referans No: AE 4162



5 YOLLU
1=M22*1,5 - 4=M16*1,5/10 BAR

DÖRTLÜ DAĞITICI VENTİL

RH 319.05

Referans No: AE 4158-4170



5 YOLLU
5=M22*1,5

DÖRTLÜ DAĞITICI VENTİL

RH 319.30

Referans No: AE 4404



RENAULT

DÖRTLÜ DAĞITICI VENTİL

RH 319.40

Referans No: AE 4440



5 YOLLU
1= M22*1,5 - 4=16*1,5

DÖRTLÜ DAĞITICI VENTİL

RH 332.00

Referans No: 934 714 1250



FORD CARGO
1=1/2 - 4=3/8

DÖRTLÜ DAĞITICI VENTİL

RH 350.00

Referans No: 934 713 004 0



FORD CARGO 2520 / 2524

DÖRTLÜ DAĞITICI VENTİL

RH 390.00
Referans No: AE 4612



7 YOLLU
1*M22*1,5 - 6=M16*1,5

DÖRTLÜ DAĞITICI VENTİL

RH 390.01
Referans No: 934 714 740 0



5 YOLLU
M22*1,5 VOSS

DÖRTLÜ DAĞITICI VENTİL

RH 390.11
Referans No: AE 4609
81521516095



RENAULT

DÖRTLÜ DAĞITICI VENTİL

RH 390.40
Referans No: AE 4605
5010 422 971



M16*1,5 - AYARLI

DORSE KONTROL VENTİLİ

RH 316.11

Referans No: 973 002 501 0



M22*1,5

ACİL DURUM VALFİ

RH 317.00

Referans No: 971 002 150 0



M16*1,5

ACİL DURUM VALFİ

RH 317.01

Referans No: 971 002 152 0



MANUEL YÜK AYAR KOLU

RH 358.00

Referans No: 475 604 011 0



MUHTELİF ARAÇLAR
M16*1,5

DORSE KONTROL VENTİLİ

RH 318.00

Referans No: AC 596 A



MUHTELİF ARAÇLAR
M22*1,5

DORSE KONTROL VENTİLİ

RH 318.01

Referans No: AC 598 C
RENAULT : 5010 260 940



MERCEDES ACTROS

DORSE KONTROL VENTİLİ

RH 338.00

Referans No : 355094001 / 000 431 95 13



M16*1,5

DORSE KONTROL VENTİLİ

RH 353.01

Referans No: 973 009 010 0



M22*1,5

DORSE KONTROL VENTİLİ

RH 353.00

Referans No: 973 009 300 0



MERCEDES ACTROS

DORSE KONTROL VENTİLİ

RH 497.50

Referans No: 480 204 002 0



DORSE

ABS PARK BUTONU

RH 452.00

Referans No: 963 001 051 0



DORSE

EBS PARK BUTONU

RH 453.00

Referans No: 971 002 900 0



M16*1,5

YÜK AYAR VENTİLİ

RH 321.01

Referans No: 475 710 020 0



FORD CARGO

YÜK AYAR VENTİLİ

RH 321.05

Referans No: 475 710 007 0

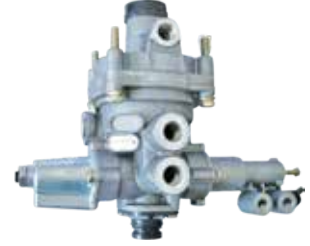

ÇEKİCİ İÇİN
M16*1,5

YÜK AYAR VENTİLİ

RH 321.10

Referans No: 475 711 108 0



ÇEKİCİ İÇİN
M22*1,5

YÜK AYAR VENTİLİ

RH 321.11

Referans No: 475 711 126 0



ÇEKİCİ İÇİN
M22*1,5

YÜK AYAR VENTİLİ

RH 321.15

Referans No: 475 714 500 0



MERCEDES ACTROS / ATEGO
ÇEKİCİ İÇİN

YÜK AYAR VENTİLİ

RH 321.20

Referans No: 475 710 136 0



ÇEKİCİ İÇİN
M22*1,5

YÜK AYAR VENTİLİ

RH 321.25

Referans No: 475 710 008 0



DORSE DENİZALTI VENTİL

RH 342.00

Referans No: 475 715 500 0



LSV KOLU / LSV KOLU KISA

KIRKAYAK KALDIRMA KOLU

RH 722.00 / RH 722.01

Referans No : 433 302 016 0
433 302 008 0



M22*1,5

TÜP AYAR REGÜLATÖRÜ

RH 314.00

Referans No: 434 100 124 0



M22*1,5

BASINÇ AYAR VALFİ

RH 352.00

Referans No: 475 010 400 0



M22*1,5

BASINÇ AYAR VALFİ

RH 352.10

Referans No: 475 010 301 0



M22*1,5

BASINÇ AYAR VALFİ

RH 352.20

Referans No: 0481 009 026



M16*1,5

BASINÇ AYAR VALFİ

RH 352.22

Referans No: 0481 009 017



M22*1,5

BASINÇ LİMİT VALFİ

RH 357.00

Referans No: 475 010 025 0



M16*1,5 / 3,5 - 4,5 BAR

BASINÇ LİMİT VALFİ

RH 363.00

Referans No: 475 015 400 0



M16*1,5 / 9,5 - 11 BAR

BASINÇ AYAR VALFİ

RH 363.10

Referans No: AC 156 C



M16*1,5 / 11 - 13 BAR

BASINÇ AYAR VALFİ

RH 363.11

Referans No: AC 156 E



M16*1,5 / 7,5 - 9,5 BAR

BASINÇ LİMİT VALFİ

RH 363.03

Referans No: 475 015 031 0



M22*1,5 / RENAULT / 8 - 10 BAR

BASINÇ AYAR VALFİ

RH 364.00

Referans No: AC 157 C



AD BLUE VENTİLİ

RH 365.00

Referans No: 975 009 001 0
004 431 030 6



EBS

DİNGİL KALDIRMA VALFİ

RH 340.00

Referans No: 463 084 031 0



M12*1,5

KASA KÖRÜK VENTİLİ

RH 345.00

Referans No: 464 002 330 0



DORSE / M12*1,5

KASA KÖRÜK VENTİLİ

RH 345.11

Referans No: 464 006 003 0



DORSE / M12*1,5

**KASA KÖRÜK VENTİLİ
YAVRULU**

RH 345.15

Referans No: 464 006 100 0



M12*1,5

KASA KÖRÜK VENTİLİ

RH 346.00

Referans No: SV 1294



M12*1,5

SÜSPANSİYON VENTİLİ

RH 346.02

Referans No: SV 1310



M12*1,5

KASA KÖRÜK VENTİLİ

RH 346.07

Referans No: SV 1307



M12*1,5

SÜSPANSİYON VENTİLİ

RH 346.10

Referans No: SV 1295



KNORR TİP PLASTİK

SÜSPANSİYON VENTİLİ

RH 346.15

Referans No: KN 27000



M12*1,5

SÜSPANSİYON VENTİLİ

RH 346.20
Referans No: SV 1280



SCANIA / M12*1,5

SÜSPANSİYON VENTİLİ

RH 346.24
Referans No: SV 1303



FORD CARGO

**KASA KÖRÜK VENTİLİ
KIRKAYAK**

RH 368.00
Referans No: 1C442K433A2AN



IVECO

ŞANZUMAN STOP VENTİLİRH 347.40
Referans No: K018005N00

M12*1,5

ŞANZUMAN KİLİT VALFİRH 347.10
Referans No: 463 022 020 0

MERCEDES

ŞANZUMAN STOP VENTİLİRH 347.30
Referans No: 463 013 200 0

ZF ŞANZUMAN

ŞANZUMAN VENTİLİRH 354.00
Referans No: SV 3367

ZF ŞANZUMAN

ŞANZUMAN VENTİLİRH 354.02
Referans No:
ZF 0501 310 059 / 9P912520

ZF 109 ŞANZUMAN

ŞANZUMAN KİBRİT KUTUSURH 354.03
Referans No: ZF 0501 208 629

ZF ŞANZUMAN

ŞANZUMAN VENTİLİRH 354.04
Referans No: 9P620474

ZF 109 ŞANZUMAN

ŞANZUMAN VENTİLİRH 354.05
Referans No:
6038 202 035 / 9P919135

RENAULT

ŞANZUMAN VENTİLİRH 354.25
Referans No:
5000 789 615 / 541L 9101



SCANIA
ELEKTRİKLİ EM

ŞANZUMAN VENTİLİ

RH 354.30
Referans No: 1334037



DAF EM

ŞANZUMAN VENTİLİ

RH 354.32
Referans No: 1457275 -1303948



DAF YM

ŞANZUMAN VENTİLİ

RH 354.34
Referans No: 1457276



MERCEDES
DELİKLİ

ŞANZUMAN VENTİLİ

RH 392.00
Referans No: 0022606157



REXROTH TİP

KİBRİT KUTUSU 3/2 VALF

RH 339.00

Referans No: 571 040 000 0



BMC - MERCEDES-IVECO-MAN

AYAK KUMANDA VALFİ

RH 347.00

Referans No: 463 013 0120

MERCEDES-IVECO-BPW-DAF-MAN
BMC-RENAULT**ÇAMUR TAKVİYE DÜĞMESİ**

RH 359.00

Referans No: 463 036 000 0

**HAVA HATTI FİLTRE**

RH 383.00

Referans No: 432 500 020 0

MUHTELİF ARAÇLAR
M22*1,5**ÜÇ YÖNLÜ VALF**

RH 384.00

Referans No: 434 208 000 0

FORD CARGO - BMC
3/8 REKORLU**İKİ YÖNLÜ VALF**

RH 384.01

Referans No: 481 027 024 0

MUHTELİF ARAÇLAR
M16*1,5**İKİ YÖNLÜ VALF**

RH 384.03

Referans No: 481 027 024 0

FORD-SCANIA-DAF-VOLVO
IVECO-BMC-MERCEDES**ABS MODÜLATÖRÜ**

RH 423.00

Referans No: 472 195 018 0
52RS002043RENAULT-DAF
3 FİŞLİ**ABS SELONİD VALF**

RH 423.15

Referans No: K0384381N50
472 195 0150



MERCEDES-IVECO-MAN

ABS MODÜLATÖRÜ

RH 427.00
Referans No: BR 9150
81 52452 6015



M22 - 1/2

TÜP ALTI ÇEK VALFİ

RH 700.00 / RH 701.00
Referans No:



M22 x 1,5 / M16 x 1,5

DORSE HAVA KAPLINİ SİBOPLU

RH 710.00 / RH 710.01



M22 x 1,5 / M16 x 1,5

DORSE HAVA KAPLINİ SİBOPSUZ

RH 712.00 / RH 712.01



YM

HAVA KAPLINİ FİLTRELİ

RH 714.00
Referans No: KU-1400-1410



MERCEDES-IVECO-MAN-DAF
VOLVO-RENAULT

SUSTURUCU FİLTRE KÜÇÜK / BÜYÜK

RH 725.00 / RH 725.01
Referans No: 432 407 070 0
Referans No: 432 407 015 0

PASOLU



BAJONETLİ

ISITICI KABLO

RH 726.00 / RH 726.01
Referans No:



MERCEDES

KİLOMETRE MUSUR SOKETİ

RH 726.02.00
Referans No: 356 540 0381



ZF 109 SANZUMAN

VİTES TOPUZU

RH 727.00.00
Referans No:6005 200 241
9P919398

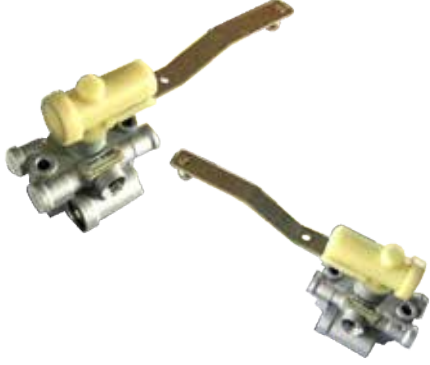

M12*1,5 / SAĞ

M12*1,5 / SOL

SÜSPANSİYON VENTİLİ

RH 310.00
Referans No:
0500 005 001

RH 310.01
Referans No:
0500 005 002

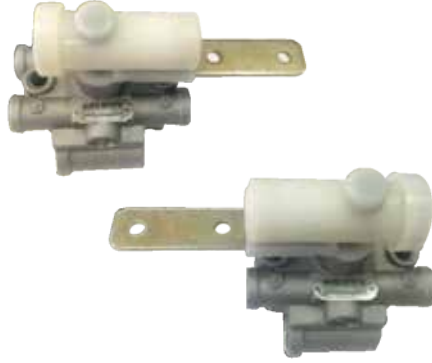

M12*1,5
KISA KOL SAĞ

M12*1,5
KISA KOL SOL

SÜSPANSİYON VENTİLİ

RH 310.02
Referans No:
0500 005 006

RH 310.03
Referans No:
0500 005 007



KABİN SÜSPANSİYON VENTİLİ

RH 389.01
Referans No: 464 007 002 0



MERCEDES

KABİN SÜSPANSİYON VENTİLİ

RH 389.02
Referans No: 464 007 011 0



KABİN SÜSPANSİYON VENTİLİ

RH 389.03
Referans No: 464 007 001 0



SCANIA

KABİN SÜSPANSİYON VENTİLİ

RH 389.04
Referans No: 464 007 010 0



RENAULT

KABİN SÜSPANSİYON VENTİLİ

RH 389.05
Referans No: 464 007 008 0
RENAULT : 5010 260060



RENAULT

KABİN SÜSPANSİYON VENTİLİ

RH 389.06
Referans No: 464 007 006 0
RENAULT : 5010 260390



BMC FATİH

EL FREN KOLU

RH 401.00

Referans No: APSA/5890



MERCEDES 304

EL FREN KOLU

RH 404.02

Referans No: 961 722 264 0



MERCEDES O403

EL FREN KOLU

RH 404.05

Referans No: 961 722 2840



BMC CARGO T BAŞLI
2 DELİK

EL FREN KOLU

RH 405.00

Referans No: 961 723 001 0



BMC CARGO
3 DELİK

EL FREN KOLU

RH 405.05

Referans No: 961 723 108 0



T BAŞLI
YANDAN 3 DELİK

EL FREN KOLU

RH 405.10

Referans No: 961 723 104 0



YANDAN 3 DELİK

EL FREN KOLU

RH 405.12

Referans No: 961 723 112 0



MERCEDES ACTROS
YANDAN 3 DELİK
ALTTAN 1 DELİK

EL FREN KOLU

RH 405.15

Referans No: 961 723 125 0



MERCEDES ACTROS
YANDAN 3 DELİK
ALTTAN 1 DELİK

EL FREN KOLU

RH 405.16

Referans No: DPM 22A



MERCEDES
6 DELİK

EL FREN KOLU

RH 405.20
Referans No: DPM 21AK
K038802N00



SCANIA

EL FREN KOLU

RH 405.40
Referans No: 961 723 122 0



FORD CARGO

EL FREN KOLU

RH 406.00
Referans No:APGA 6635



MAGIRUS

EL FREN KOLU

RH 410.00
Referans No: HB 1176



DORSE

RAMPA KOLU

RH 411.00
Referans No: 463 032 020 0



3 DELİK

EL FREN KOLU

RH 414.01
Referans No: DPM 95 AAX



TIR
MERCEDES AXOR

EL FREN KOLU

RH 415.00
Referans No:DPM 66A



KAMYON
MERCEDES AXOR

EL FREN KOLU

RH 415.01
Referans No: DPM 67 A



RENAULT

EL FREN KOLU

RH 416.00
Referans No: DPM 28 A



VOLVO - RENAULT

EL FREN KOLU

RH 416.50

Referans No : 961 721 004 0 / 6876972



VOLVO

EL FREN KOLU

RH 424.00

Referans No: 961 724 204 0 /205 0
VOLVO : 20367533 / 20367534



SCANIA

EL FREN KOLU

RH 424.10

Referans No: 961 724 206 0 / 207 0
SCANIA : 1524958



DAF - SCANIA

EL FREN KOLU

RH 424.20

Referans No: 961 724 209 0 /
SCANIA : 1548207 / DAF : 1524319



VOLVO

EL FREN KOLU

RH 425.00

Referans No: 20375553



DAF

EL FREN KOLU

RH 439.00

Referans No: DPM 90 D / 1389075



MAN

EL FREN KOLU

RH 439.10

Referans No: DPM 90 CK



BMC FATİH - FORD CARGO

HAVALI DEBRİYAJ MERKEZİ

RH 902.00

Referans No: APGA 1605



FORD CARGO 2524 / 3230

HAVALI DEBRİYAJ MERKEZİ

RH 902.10

Referans No: 5C46-7K626-AB



BMC PRO 827

HAVALI DEBRİYAJ MERKEZİ

RH 905.02

Referans No: 970 051 102 0



VOLVO - 80 MM

HAVALI DEBRİYAJ MERKEZİ

RH 912.00

Referans No: 626392 AM-1673067-1655639



VOLVO - 95MM

HAVALI DEBRİYAJ MERKEZİ

RH 912.01

Referans No: 626639 AM-1521371-1671953



DAF XF95-CF75-CF85

HAVALI DEBRİYAJ MERKEZİ

RH 912.08

Referans No: 628259AM



SCANIA P,G,R,T - 100 MM

HAVALI DEBRİYAJ MERKEZİ

RH 912.09

Referans No: 629683AM
1454590 1421186
1469161 1513717MAN-IVECO
GENİŞ TİP**HAVALI DEBRİYAJ MERKEZİ**

RH 914.00

Referans No: VG 3208



MERCEDES PENTOSİNLİ

HAVALI DEBRİYAJ MERKEZİ

RH 918.09

Referans No: 970 051 441 0



MERCEDES ACTROS
AXOR-ATEGO

HAVALI DEBRİYAJ MERKEZİ

RH 918.10
Referans No: 970 051 431 0



FORD CARGO 1835/1832/
1838/3232/2532
PRO 1144

HAVALI DEBRİYAJ MERKEZİ

RH 918.12
Referans No:970 051 455 0
AC467K626AA



MAN TGA PENTOSİNLİ

HAVALI DEBRİYAJ MERKEZİ

RH 918.41
Referans No: 970 051 466 0



MERCEDES-IVECO

HAVALI DEBRİYAJ MERKEZİ

RH 920.00
Referans No: 970 051 158 0



MERCEDES-PENTOSİNLİ

HİDROLİK DEBRİYAJ MERKEZİ

RH 935.05
Referans No: 321027001 / 0002570177



SAFİR OTOBÜS

HAVALI DEBRİYAJ MERKEZİ

RH 939.00
Referans No: 642 03 505



SCANIA 93/113/143

HİDROLİK DEBRİYAJ MERKEZİ

RH 940.00
Referans No: KG 250004.02
1105332 - 1114685



SCANIA

HİDROLİK DEBRİYAJ MERKEZİ

RH 941.00
Referans No: 631522AM
1800442-1523400-1927829



DAF F85-95

HİDROLİK DEBRİYAJ MERKEZİ

RH 942.00
Referans No: 626760AM
1348733



DAF XF 95-105

HİDROLİK DEBRİYAJ MERKEZİ

RH 943.00

Referans No: 626762AM
1348735

MAN

HİDROLİK DEBRİYAJ MERKEZİ

RH 945.00

Referans No: 81307156119
81307156121-81307156111MAN
KG23030.0.2**HİDROLİK DEBRİYAJ MERKEZİ**

RH 946.00

Referans No: 81307156135



MAN TGA

HİDROLİK DEBRİYAJ MERKEZİ

RH 947.00

Referans No: 81307156132
KG 250006-02

MERCEDES

HİDROLİK DEBRİYAJ MERKEZİ

RH 948.00

Referans No: KG 20001.0.8 / 0012959106



MERCEDES

HİDROLİK DEBRİYAJ MERKEZİ

RH 949.00.00

Referans No: KG 190110.4.1 / 022950806



RENAULT PREMIUM

**DEBRİYAJ ÜST MERKEZİ
TAMİR KİTİ**

RH 950.00

Referans No:
965 001 902 2 - 5001 864 263

RENAULT 420

HİDROLİK DEBRİYAJ MERKEZİ

RH 951.00

Referans No: 5010251357 / 5000792359



MERCEDES

HİDROLİK DEBRİYAJ MERKEZİ

RH 952.00

Referans No: KG 20003.4.2 / 0022951006



MERCEDES

HİDROLİK DEBRİYAJ MERKEZİ

RH 953.00

Referans No: KG 2395.1.3 / 0012956006



MERCEDES

HİDROLİK DEBRİYAJ MERKEZİ

RH 954.00

Referans No: KG 23021.1.3 / 0012955306



MERCEDES

HİDROLİK DEBRİYAJ MERKEZİ

RH 955.00

Referans No: KG 190084.0.1 / 0022958206



MERCEDES

HİDROLİK DEBRİYAJ MERKEZİ

RH 956.00

Referans No: KG 190084.0.2 / 0022950306



MERCEDES

HİDROLİK DEBRİYAJ MERKEZİ

RH 957.00

Referans No: KN 28022 D1 / 0012954507



VOLVO

HİDROLİK DEBRİYAJ MERKEZİ

RH 958.00

Referans No: KG 28014.1.1 / 1620462
1581209 / DAF : 276834



VOLVO

HİDROLİK DEBRİYAJ MERKEZİ

RH 959.00

Referans No: KG 28012.0.1 / 168218



VOLVO

HİDROLİK DEBRİYAJ MERKEZİ

RH 960.00

Referans No: KG 28019.4.2 - 20835246



IVECO

HİDROLİK DEBRİYAJ MERKEZİ

RH 961.00

Referans No: K013984 - 41285167



IVECO

HİDROLİK DEBRİYAJ MERKEZİ

RH 962.00

Referans No: KG 3107.0.1 / 41211005



IVECO M16*1,5

İMDATLI FREN KÖRÜĞÜ

RH 840.00
Referans No: 1186753



12*6200 / M16*1,5

İMDATLI FREN KÖRÜĞÜ

RH 852.00

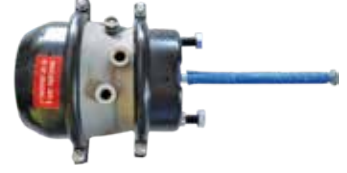

24*30 D/D / M16*1,5

İMDATLI FREN KÖRÜĞÜ

RH 860.00



30*30 D/D / M16*1,5

İMDATLI FREN KÖRÜĞÜ

RH 861.00



24*24 D/D / M16*1,5

İMDATLI FREN KÖRÜĞÜ

RH 862.00



24*30 D/D DERİN / DORSE TİPİ
M16*1,5

İMDATLI FREN KÖRÜĞÜ

RH 863.00



30*30 D/P / M16*1,5

İMDATLI FREN KÖRÜĞÜ

RH 875.00



24*24 D/P / M16*1,5

**TAMİRSİZ
İMDATLI FREN KÖRÜĞÜ**

RH 872.08
Referans No:



24 TİP / M16*1,5

SERVİS FREN KÖRÜĞÜ

RH 832.00
Referans No:



30 TİP / M16*1,5

SERVİS FREN KÖRÜĞÜ

RH 833.00
Referans No:



30 TİP / DERİN TİP DORSE / M16*1,5

SERVİS FREN KÖRÜĞÜ

RH 834.00



16*24 D/D / M 16*1,5

DİSK FREN KÖRÜĞÜ
RH 821.00



16*24 D/D ÜZERİNDEKİ BORU
FREN KÖRÜK BORUSU
RH 821.10



16*24 D/P / M22*1,5

**TAMİRSİZ DİSK
İMDATLI FREN KÖRÜĞÜ**
RH 812.01
Referans No:



20*24 D/P / M22*1,5

**TAMİRSİZ DİSK
İMDATLI FREN KÖRÜĞÜ**
RH 815.01
Referans No:



24*24 D/P / M22*1,5

**TAMİRSİZ DİSK
İMDATLI FREN KÖRÜĞÜ**
RH 816.01
Referans No:925 481 270 0



16 TİP / M 22*1,5 / 2 Delik

**DİSK SERVİS
FREN KÖRÜĞÜ**
RH 880.15
Referans No:



20 TİP / M22*1,5
2 Delik

**DİSK SERVİS
FREN KÖRÜĞÜ**
RH 881.00
Referans No:



24 TİP / M22*1,5
2 Delik

**DİSK SERVİS
FREN KÖRÜĞÜ**
RH 882.00
Referans No:



**9 TİP
DİYAFRAM LASTİĞİ STD**
RH 890.01



**12 TİP
DİYAFRAM LASTİĞİ STD**
RH 890.02



**16 TİP
DİYAFRAM LASTİĞİ STD**
RH 890.03



**20 TİP
DİYAFRAM LASTİĞİ STD**
RH 890.04



**24 TİP
DİYAFRAM LASTİĞİ STD**
RH 890.05



**30 TİP
DİYAFRAM LASTİĞİ STD**
RH 890.06



**36 TİP
DİYAFRAM LASTİĞİ STD**
RH 890.08



**12 TİP
DİYAFRAM LASTİĞİ DERİN**
RH 891.02



**16 TİP
DİYAFRAM LASTİĞİ DERİN**
RH 891.03



**20 TİP
DİYAFRAM LASTİĞİ DERİN**
RH 891.04



**24 TİP
DİYAFRAM LASTİĞİ DERİN**
RH 891.05



**30 TİP
DİYAFRAM LASTİĞİ DERİN**
RH 891.06



**27 TİP
DİYAFRAM LASTİĞİ DERİN**
RH 891.07



**36 TİP
DİYAFRAM LASTİĞİ DERİN**
RH 891.08



Bertocco







MAN

ECAS SEVİYE VENTİLLERİ

RH 442.02

Referans No: 441 050 011 0



SCANIA

ECAS SEVİYE SENSÖRÜ

RH 442.04

Referans No: 1889797



BMC

ECAS SEVİYE VENTİLLERİ

RH 442.08

Referans No: 441 050 100 0

RENAULT : 5010422344

DAF : 1365935



MERCEDES-IVECO
STRALIS

ECAS SEVİYE VENTİLLERİ

RH 442.10

Referans No: 441 050 120 0



MERCEDES
AXOR

ECAS SEVİYE VENTİLLERİ

RH 442.11

Referans No: 441 050 121 0



MERCEDES AROCS

ECAS SEVİYE SENSÖRÜ

RH 442.16

Referans No: 441 050 200 0



SENONİD VALF

RH 450.00
Referans No: 472 170 600 0



CARGO-BMC

SENONİD VALF

RH 451.00
Referans No: 472 170 606 0



MERCEDES

SENONİD VALF

RH 454.00
Referans No: 472 172 901 0 / 0009975212



MERCEDES YENİ MODEL

SENONİD VALF

RH 455.00
Referans No: 472 170 001 0



MERCEDES

SENONİD VALF

RH 456.00
Referans No: 472 070 639 0



BMC

**SENONİD VALF
STOP BOBİNİ**

RH 457.00
Referans No: 472 173 700 0



SENONİD VALF

RH 458.00
Referans No: 472 176 316 0

L



KAMPANA FREN İÇİN

ABS SENSÖR 40 CM.

RH 730.00

Referans No: 441 032 808 0

L



KAMPANA FRENLER İÇİN

ABS SENSÖR 100 CM.

RH 732.00

Referans No: 441 032 809 0

L



KAMPANA FRENLER İÇİN

ABS SENSÖR 200 CM.

RH 733.00

Referans No: 441 032 8230

DÜZ



MERCEDES
DİSK FREN İÇİN

ABS SENSÖR 35 CM.

RH 734.00

Referans No: 441 032 905 0

DÜZ



DİSK FREN İÇİN

ABS SENSÖR 250 CM.

RH 736.00

Referans No: 441 032 920 0



ACTROS

ABS SENSÖR 160 CM.

RH 739.00

Referans No: 001 153 0220



WABCO TİPİ

BAĞLANTI KABLOSU 380 CM.

RH 740.00

Referans No: 449 712 038 0



EBS ARA UZATMA KABLOSU 300 CM.

RH 743.00

Referans No: 449 723 030 0



KNORR TİPİ

EBS ARA UZATMA KABLOSU

RH 743.10

Referans No: K027832

L



IVECO (SOKETLİ)
STRALIS

ABS SENSÖR 200 CM.

RH 744.00

Referans No: 441 032 8580

DÜZ



RENAULT - SCANİA
SOKETLİ SAĞ - SOL

ABS SENSÖR 265 CM.

RH 745.00

Referans No: 441 032 386 0 / 70

DÜZ



ABS SENSÖR 180 CM.

RH 746.00

Referans No: 441 032 900 0

L



RENAULT - SCANIA
SOKETLİ SAĞ - SOL

ABS SENSÖR 265 CM.

RH 747.00

Referans No: 5010 422 021 / 22



MERCEDES - AXOR SOL

ABS SENSÖR

RH 748.00

Referans No: 655 640 0817



MERCEDES - AXOR SAĞ

ABS SENSÖR

RH 749.00

Referans No: 655 640 0717



SCANIA

ABS SENSÖR

RH 750.00

Referans No: 1892028



SCANIA

ABS SENSÖR

RH 751.00

Referans No: 1892049



SCANIA

ABS SENSÖR 265 CM.

RH 752.00

Referans No: 1892058



MAN

ABS SENSÖR

RH 755.00

Referans No: 81271206067



MAN

ABS SENSÖR

RH 756.00

Referans No: 81271206068



MAN

ABS SENSÖR

RH 757.00

Referans No: 4410329880



MAN

ABS SENSÖR

RH 757.10

Referans No: 4410329870



MAN - TGA / TGS

ABS SENSÖR

RH 775.00

Referans No: 441 032 2830
441 032 2960



MAN - TGA / TGS

ABS SENSÖR

RH 776.00

Referans No: 441 032 2840 441 032 2970



MAN TGA - TGS

ABS SENSÖR

RH 777.00

Referans No: 441 032 2850



MAN TGA - TGS

ABS SENSÖR

RH 778.00

Referans No:441 032 2860



**KALİPER KAPAK ARA
KABLO 3 FİŞLİ**

RH 779.00

Referans No: 449 758 0220



SCANIA

**KALİPER KAPAK ARA
KABLO 3 FİŞLİ**

RH 779.01

Referans No:



IVECO

ABS SENSÖR ÖN

RH 738.01

Referans No: 5801279030



IVECO

ABS SENSÖR ARKA

RH 738.02

Referans No: 5801279032



IVECO

ABS SENSÖR ARKA

RH 738.03

Referans No: 5801279037



MERCEDES AROCS

ABS SENSÖR

RH 780.00

Referans No: 4410323960



MERCEDES AROCS

ABS SENSÖR

RH 780.10

Referans No: 4410323970



MAN

ABS SENSÖR

RH 783.00

Referans No: 81271206176



MAN

ABS SENSÖR

RH 783.01

Referans No: 81271206177



MAN

ABS SENSÖR

RH 784.00

Referans No: 81271206125



MAN

ABS SENSÖR

RH 784.01

Referans No: 81271206125

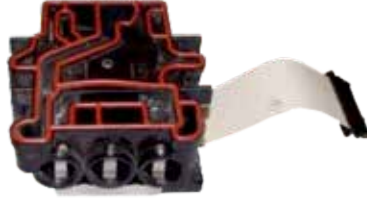

EBS

BASINC SENSÖRÜ

RH 0013

Referans No:4741500011



MAN TGA ARKA-SOL

BALATA SENSÖRÜ

RH 761.00

Referans No: 81.25937.6041



MAN TGA ARKA-SAĞ

BALATA SENSÖRÜ

RH 762.00

Referans No: 81.25937.6044



VOLVO SOL FH 12-16

BALATA SENSÖRÜ

RH 763.00

Referans No: 20928541



VOLVO SAĞ FH / FM

BALATA SENSÖRÜ

RH 764.00

Referans No: 21390374



RENAULT - VOLVO ARKA SAĞ

BALATA SENSÖRÜ

RH 765.00

Referans No: 7420 928 553



VOLVO SOL-ÖN / RENAULT ÖN SOL

BALATA SENSÖRÜ

RH 766.00

Referans No: 7420 928 559



VOLVO FH - RENAULT ÖN SAĞ

BALATA SENSÖRÜ

RH 766.01

Referans No: 7420 928 560



VOLVO ARKA-SOL

BALATA SENSÖRÜ

RH 767.00

Referans No: 7420 928 552



VOLVO ÖN

BALATA SENSÖRÜ

RH 768.00

Referans No: 20928533



VOLVO ARKA

BALATA SENSÖRÜ

RH 769.00

Referans No:20928532



RENAULT ÖN-SAĞ

BALATA SENSÖRÜ

RH 770.00

Referans No: 5001 856 032



RENAULT ARKA-SAĞ

BALATA SENSÖRÜ

RH 771.00

Referans No: 5001 856 034



RENAULT ÖN-SOL

BALATA SENSÖRÜ

RH 772.00

Referans No: 5001 856 031



RENAULT ARKA - SOL

BALATA SENSÖRÜ

RH 773.00

Referans No: 5001 856 033



RENAULT 460 T KABİN

BALATA SENSÖRÜ

RH 781.00

Referans No: 742196869



RENAULT 460 T KABİN

BALATA SENSÖRÜ

RH 781.10

Referans No: 742196868

FREN MALZEMELERİ



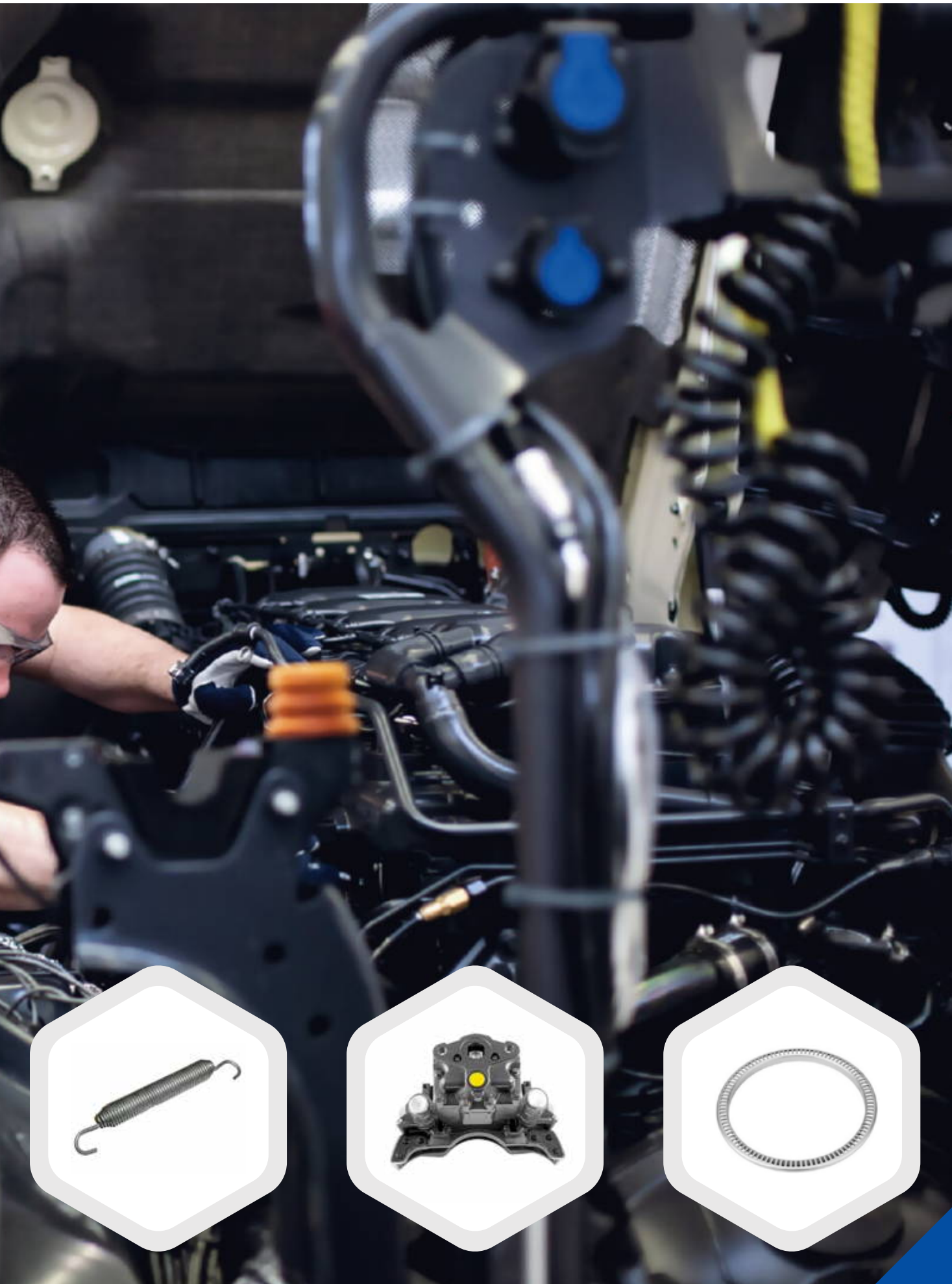



MUHTELİF

**KABİN TEMİZLEME
HORTUMU**

46071



MERCEDES ATEGO - AXOR JACKLI

**KABİN TEMİZLEME
HORTUMU**

46072



ACTROS

**KABİN TEMİZLEME
HORTUMU**

46073



RENAULT

**KABİN TEMİZLEME
HORTUMU**

46075



SCANIA

**KABİN TEMİZLEME
HORTUMU**

46076



**DORSE HAVA
HORTUMU**

49307



4,5 Mt.

**7'Lİ EBS DORSE
ELEKTRİK KABLOSU**

SMR 030-171



4,5 Mt.

**15'Lİ EBS DORSE
ELEKTRİK KABLOSU**

SMR 030-181



4,5 Mt.

**(15-7x2) EBS DORSE
ELEKTRİK KABLOSU**

SMR 030-191PM



4,5 Mt. Dişi

**N TİPİ 7'Lİ DORSE
ELEKTRİK KABLOSU**
SMR 030-201



4,5 Mt. ERKEK

**S TİPİ 7'Lİ DORSE
ELEKTRİK KABLOSU**
SMR 030-211



METAL Dişi

**N TİPİ 7'Lİ KAPAKLI
ELEKTRİK SOKETİ**
SMR 080-01



METAL ERKEK

**S TİPİ 7'Lİ KAPAKLI
ELEKTRİK SOKETİ**
SMR 080-02



PLASTİK Dişi

**N TİPİ 7'Lİ KAPAKLI
ELEKTRİK SOKETİ**
SMR 020-01



PLASTİK ERKEK

**S TİPİ 7'Lİ KAPAKLI
ELEKTRİK SOKETİ**
SMR 020-02



ADR 7 LI KAPAKLI FIS
SMR 020-04



ADR 15 LI KAPAKLI FIS
SMR 020-05



6*4 (100 METRE)

POLYEMİT HORTUM
RH 785.00



8*6 (100 METRE)

POLYEMİT HORTUM
RH 786.00



10*8 (100 METRE)

POLYEMİT HORTUM
RH 787.00



12*9 (100 METRE)

POLYEMİT HORTUM
RH 788.00



15X12 (50 METRE)

POLYEMİT HORTUM
RH 789.00



16X12 (50 METRE)

POLYEMİT HORTUM
RH 790.00



9X6 (100 METRE)

POLYEMİT HORTUM
RH 791.00



ESKİ MODEL

KALİPER AYAR TAŞIYICI

RH 1032



ESKİ MODEL

KALİPER AYAR CİVATASI

RH 1008



69 mm

KALİPER AYAR TOZ LASTİK ŞAPKA TAKIMI

RH 1038



69 mm

KALİPER AYAR TOZ LASTİK ŞAPKA TAKIMI

RH 1127



74 mm

KALİPER AYAR TOZ LASTİK ŞAPKA TAKIMI

RH 1015



74 mm

KALİPER AYAR TOZ LASTİK ŞAPKA TAKIMI

RH 1016



ANAHTAR BAŞLI

KALİPER AYAR MEKANİZMASI

RH 1029



12.160 / 12.180 MAN

KALİPER AYAR MEKANİZMASI

RH 1064



YILDIZ BAŞLI

KALİPER AYAR MEKANİZMASI

RH 1209



**KALİPER
AYAR MEKANİZMA ZİNCİRİ**
RH 1031



12.160 MAN
**KALİPER
AYAR MEKANİZMA ZİNCİRİ**
RH 1169



**KALİPER
AYAR MEKANİZMA DİŞLİSİ**
RH 1011



ORTA MODEL

KALİPER AYAR TAŞIYICI
RH 1041



**KALİPER AYAR TAŞIYICI
MİL-SAÇ TAKIMI**
RH 1100



Kısa Pim 34x80
Uzun Pim 36x145

**KALİPER
PERNO BURÇ TAMİR TAKIMI**
RH 1002



Kısa Pim 34x80
Uzun Pim 36x113,70

**KALİPER
PERNO BURÇ TAMİR TAKIMI**
RH 1027

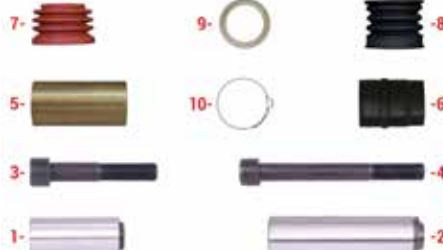

Kısa Pim 34x80
Uzun Pim 36x135

**KALİPER
PERNO BURÇ TAMİR TAKIMI**
RH 1025



Uzun Tip

**KALİPER METALLİ
KAUÇUK BURÇ**
RH 1522



MERCEDES - MAN - IVECO
DORSEY

KALİPER SABİT AYAR

RH 1030



KISA TİP

KALİPER METALLİ KAUÇUK BURÇ

RH 1523



KALİPER PERNO TOZ KEÇESİ

RH 1531



PERNO 32x80

KALİPER PERNO BURÇ TAMİR TAKIMI 1/2

RH 1090

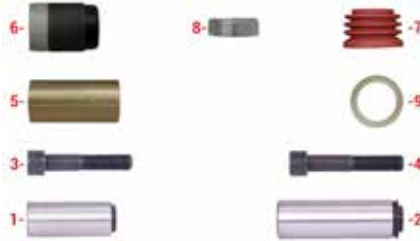

KISA PERNO 32x80
UZUN PERNO 36x113,70

KALİPER PERNO BURÇ TAMİR TAKIMI

RH 1040



PERNO 32x80

KALİPER PERNO BURÇ TAMİR TAKIMI 1/2

RH 1205

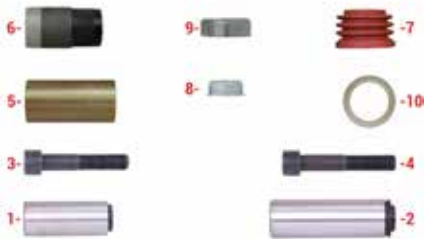

KISA PERNO 32x80
UZUN PERNO 36x113,70

KALİPER PERNO BURÇ TAMİR TAKIMI

RH 1039



KALİPER SAÇ KAPAK

RH 1045



YENİ MODEL

KALİPER SAÇ KAPAK

RH 1046



YENİ MODEL

KALİPER AYAR TAŞIYICI

RH 1042



TIRNAKLI

**KALİPER
YARIM AY RULMAN TAKIMI**

RH 1005



YENİ MODEL

**KALİPER
YARIM AY RULMAN TAKIMI**

RH 1069



KISA PERNO 32x80
UZUN PERNO 36x113,70

**KALİPER PERNO BURÇ
TAMİR TAKIMI**

RH 1184



SENSÖRSÜZ KAPAĞ

KALİPER ZİNCİR KAPAĞI

RH 1019



3 FİŞLİ MERCEDES

**KALİPER ZİNCİR KAPAĞI
SENSÖRLÜ**

RH 1070



2 FİŞLİ MERCEDES

**KALİPER ZİNCİR KAPAĞI
SENSÖRLÜ**

RH 1033



3 FİŞLİ MAN

**KALİPER ZİNCİR KAPAĞI
SENSÖRLÜ**

RH 1074



12.160 MAN

KALİPER AYAR TAŞIYICI

RH 1014



12.180 MAN
UZUN PERNO: 30x99
KISA PERNO: 29,70x71,50

**KALİPER
PERNO BURÇ TAMİR TAKIMI**
RH 1173



12.180 MAN

**KALİPER AYAR TOZ
LASTİK ŞAPKA TAKIMI**
RH 1001



12.180 MAN

KALİPER AYAR TAŞIYICI
RH 1177



12.180 MAN

**KALİPER YARIM AY
RULMAN TAKIM**
RH 1174



12.180 MAN

KALİPER SAÇ KAPAK
RH 1047



12.160 MAN

**KALİPER
YARIM AY RULMAN TAKIMI**
RH 1168



SCANIA R 420
UZUN PERNO: 36x113,70
KISA PERNO: 32x84

**KALİPER PERNO
BURC TAMİR TAKIMI**
RH 1061



**KALİPER RULMAN YATAĞI
BURCU**
RH 1182



**KALİPER BALATA
TUTUCU LEVYE TAKIMI**
RH 1060



12.160 MAN

**KALİPER RULMAN
YATAĞI (KAŞIK)**

RH 1180



0 - 114 MM

**KALİPER RULMAN
YATAĞI (KAŞIK)**

RH 1035



0 - 127 MM

**KALİPER RULMAN
YATAĞI (KAŞIK)**

RH 1171



12 - 122 MM

**KALİPER RULMAN
YATAĞI (KAŞIK)**

RH 1206



0 - 124 MM

**KALİPER RULMAN
YATAĞI (KAŞIK)**

RH 1043

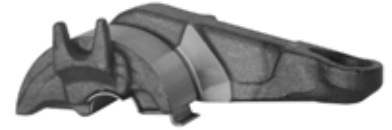

0 - 113 MM

**KALİPER RULMAN
YATAĞI (KAŞIK)**

RH 1044



12 - 122 MM

**KALİPER RULMAN
YATAĞI (KAŞIK)**

RH 1176



0 - 113 MM

**KALİPER RULMAN
YATAĞI (KAŞIK) BİLYALI**

RH 1178



12 - 122 MM

**KALİPER RULMAN
YATAĞI (KAŞIK) BİLYALI**

RH 1179



12.180 TGL MAN

**KALİPER RULMAN
YATAĞI (KAŞIK)**
RH 1183**KALİPER YARIM
AY RULMAN TAKIMI**
RH 1168

12.180 TGL MAN

**KALİPER AYAR
MEKANİZMA ZİNCİRİ**
RH 1007

YENİ MODEL

**KALİPER
ŞAPKA TAMİR TAKIMI 1/2**
RH 1053

YENİ MODEL

**KALİPER
ŞAPKA TAMİR TAKIMI**
RH 1056

YENİ MODEL

KALİPER AYAR CİVATASI
RH 1009**KALİPER SABİT AYAR**

RH 1105



SCANIA 2 FİŞLİ

**KALİPER ZİNCİR KAPAĞI
SENSÖRLÜ**

RH 1021



SCANIA 3 FİŞLİ

**KALİPER ZİNCİR KAPAĞI
SENSÖRLÜ**

RH 1071



22,5

KALİPER TAŞIYICI

RH 1211



19,5

KALİPER TAŞIYICI

RH 1214



AXOR 22,5

KALİPER TAŞIYICI

RH 1215



DORSE 22,5

KALİPER TAŞIYICI

RH 1230



AXOR EM 22,5

KALİPER TAŞIYICI

RH 1231



DORSE JUMBO 19,50

KALİPER TAŞIYICI

RH 1233



4140 ARKA 22,50

KALİPER TAŞIYICI

RH 1235



AXOR YENİ MODEL

**KALİPER
FULL SET**

KLP SET 1009



AXOR

**KALİPER
FULL SET**

KLP SET 1008



DORSE

**KALİPER
FULL SET**
KLP SET 1016



KISA PERNO 30x77,30
UZUN PERNO 30x91
12.153 MAN

**KALİPER PERNO
BURC TAMİR TAKIMI**
RH 3143



SAF / 12.153 MAN

KALİPER TOZ LASTİĞİ
RH 3531



KISA PERNO 37,70x76
UZUN PERNO 38x118
SAF

**KALİPER PERNO
BURC TAMİR TAKIMI**
RH 3156



12.153 MAN

KALİPER AYAR ÇİVATASI
RH 3146



SAF

KALİPER AYAR ÇİVATASI
RH 3165



12.153 MAN

**KALİPER BALATA PLEYTİ
R**
RH 3152



12.153 MAN

**KALİPER BALATA PLEYTİ
L**
RH 3151



SAF

**KALİPER BALATA PLEYTİ
R**
RH 3162



SAF

**KALİPER BALATA PLEYTİ
L**
RH 3161



SAF - 12.153 MAN

**KALİPER
YARIM AY RULMAN TAKIMI**
RH 3148



KISA PERNO 37,70x76
UZUN PERNO 38x118
RENAULT

**KALİPER PERNO BURÇ
TAMİR TAKIMI**
RH 3201



12.153 MAN

**KALİPER AYAR TAŞIYICI
MEKANİZMA SETİ**
RH 3172



SAF

**KALİPER AYAR TAŞIYICI
MEKANİZMA SETİ**
RH 3173



12.153 MAN - SAF

**KALİPER
CONTA KEÇE TAKIMI**
RH 3150



12.153 MAN - SAF

**KALİPER RULMAN YATAĞI
(ÇATAL)**
RH 3149



SAF ORTA MODEL

**KALİPER BALATA PLEYTİ
R**
RH 3159



SAF ORTA MODEL

**KALİPER BALATA PLEYTİ
L**
RH 3158



RENAULT MİDLUM

**KALİPER YARIM AY
RULMAN TAKIM**
RH 3209



RENAULT MIDLUM

**KALİPER YARIM AY
RULMAN TAKIMI**
RH 3210



MAXX 22 - MN TGX

**KALİPER
AYAR MEKANİZMA SETİ**
RH 3141



MAXX 22 - MN TGX - AROCS

**KALİPER
ELLE AYAR DİŞLİSİ**
RH 3137



KISA PERNO 37,70x76
UZUN PERNO 38x118
MAXX 22 - MN TGX - AROCS

**KALİPER PERNO
BURC TAMİR TAKIMI**
RH 3140



MAXX 22 - MN TGX

**KALİPER
RULMAN YATAĞI (KAŞIK)**
RH 3131



MAXX 22 - MN TGX - AROCS

KALİPER SAÇ KAPAK
RH 3138



MAXX 22 - MN TGX - AROCS

**KALİPER YARIM AY
RULMAN TAKIMI**
RH 3135



MAXX 22 - MN TGX - AROCS

**KALİPER BALATA PLEYTİ
R**
RH 3128



MAXX 22 - MN TGX - AROCS

**KALİPER BALATA PLEYTİ
L**
RH 3129



MAXX 22 - MN TGX - AROCS

**KALİPER
AYAR ÇİVATASI**
RH 3588



MAXX22 - MN TGX

**KALİPER SENSÖRLÜ
KAPAK**
RH 3267

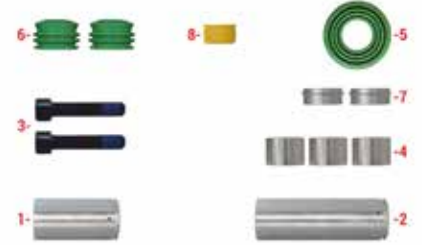

KISA PERNO 37,70x76
UZUN PERNO 38x63/118
MAXX22 T - SCHMITZ DORSE

**KALİPER PERNO BURÇ
TAMİR TAKIMI**
RH 3100



MAXX22 - SCHMITZ DORSEY

**KALİPER AYAR TAŞIYICI
MEKANİZMA SETİ**
RH 3101



MAXX22 - SCHMITZ DORSE

KALİPER SAÇ KAPAK
RH 3103



MAXX22 - SCHMITZ DORSEY

**KALİPER RULMAN
YATAĞI (KAŞIK)**
RH 3102



MAXX 22 - AROCS

**KALİPER SENSORLU
KAPAK**
RH 3190



MAXX 22 - AROCS

**KALİPER RULMAN
YATAĞI (KAŞIK)**
RH 3126



MAXX 22 - AROCS - MN TGS

**KALİPER AYAR TAŞIYICI
MEKANİZMA SETİ**
RH 3142



SAĞ 19,5

KALİPER TAŞIYICI

RH 3273



SOL 19,5

KALİPER TAŞIYICI

RH 3274



RENAULT MIDLUM

**KALİPER RULMAN YATAĞI
(KAŞIK)**

RH 3181

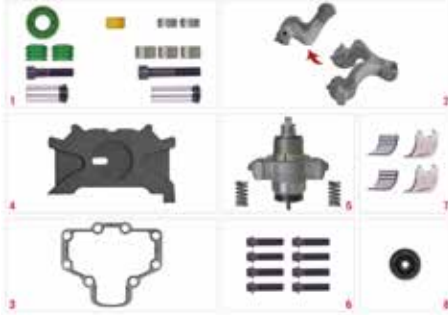

12.153 MAN SAĞ

FULL SET

KLP SET 3001

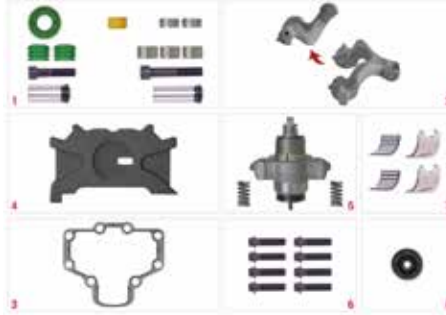

12.153 MAN SOL

FULL SET

KLP SET 3002



AROCS SAĞ

FULL SET

KLP SET 3013



AROCS SOL

FULL SET

KLP SET 3014



**KALİPER
ŞAPKALI MİL TAKIMI**
RH 5007



KISA PERNO 36,40x70
UZUN PERNO 37x123

**KALİPER PERNO
BURÇ TAMİR TAKIMI**
RH 5003



**KALİPER TAPA
TOZ LASTİK TAKIMI**
RH 5001



**KALİPER YARIM AY
RULMAN TAKIMI**
RH 5005



**KALİPER
RULMAN YATAĞI (KAŞIK)**
RH 5022



**KALİPER
ELLE AYAR MİLİ**
RH 5018



9 TON

**KOMPLE MEKANİZMA
SETİ**
RH 5023



**BALATA TUTUCU
SETİ**
RH 5024



12 TON

**KOMPLE MEKANİZMA
SETİ**
RH 5029



9 TON + RULMANLI KAŞIK

KOMPLE MEKANİZMA SETİ
RH 5032



12 TON + RULMANLI KAŞIK

KOMPLE MEKANİZMA SETİ
RH 5033



RULMAN KAŞIK
RH 5034



9 TON

FULL SET
KLP SET 5002



12 TON

FULL SET
KLP SET 5004



VOLVO - RENAULT

**KALİPER
AYAR TOZ LASTİĞİ
RH 2111**

KISA PERNO 35x72,50
UZUN PERNO 35x135

**KALİPER PERNO
BURC TAMİR TAKIMI
RH 2067**

PERNO 35x102
VOLVO

**KALİPER PERNO
BURC TAMİR TAKIMI
RH 2108**

KISA PERNO 28,50x84,50
UZUN PERNO 35x135

**KALİPER PERNO
BURC TAMİR TAKIMI
RH 2141**

RENAULT 420 - 440
KISA PERNO 35x79
UZUN PERNO 35x132

**KALİPER PERNO BURC
TAMİR TAKIMI
RH 2128**

RENAULT 400-420 / 440 VOLVO
KISA PERNO 31x83,50
UZUN PERNO 35x144

**KALİPER PERNO BURC
TAMİR TAKIMI
RH 2231**

KISA PERNO 32x72,70
UZUN PERNO 32x117

**KALİPER PERNO BURC
TAMİR TAKIMI
RH 2265**

VOLVO
KISA PERNO 35x60
UZUN PERNO 35x102

**KALİPER PERNO
BURC TAMİR TAKIMI
RH 2109**



**KALİPER
YARIM AY RULMAN TAKIMI
RH 2071**



RENAULT 400 - 420

**KALİPER
ELLE AYAR MİLİ L**
RH 2138



RENAULT 400 - 420

**KALİPER
ELLE AYAR MİLİ R**
RH 2137



RENAULT 420 - 440

**KALİPER AYAR
TOZ LASTİK ŞAPKA TAKIMI**
RH 2189



KISA PERNO 30,90x77,50
UZUN PERNO 35x117

**KALİPER PERNO BURC
TAMİR TAKIMI**
RH 2045



KISA PERNO 31x117
UZUN PERNO 35x117

**KALİPER PERNO BURC
TAMİR TAKIMI**
RH 2247



KISA PERNO 35,33x66,50
UZUN PERNO 35x128

**KALİPER PERNO BURC
TAMİR TAKIMI**
RH 2214



**KALİPER
RULMAN YATAĞI**
RH 2140



VOLVO - RENAULT

**KALİPER
RULMAN YATAĞI (KAŞIK)**
RH 2195



VOLVO - RENAULT

**KALİPER RULMAN YATAĞI
BİLYA BURC TAKIMI**
RH 2070



VOLVO

**KALİPER
ELLE AYAR MİLİ**
RH 2188



VOLVO

**KALİPER
ŞAPKA TAMİR TAKIMI**
RH 2112

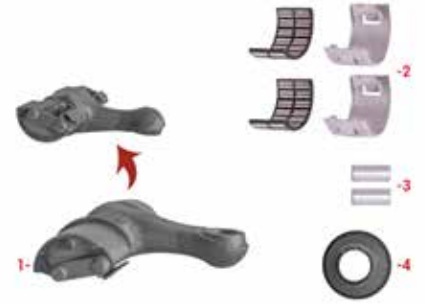

VOLVO ARKA SAĞ

**KALİPER
RULMAN YATAĞI (KAŞIK) R**
RH 2121

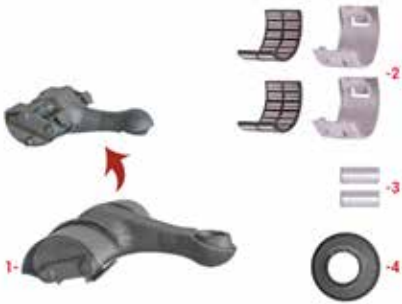

VOLVO ARKA SOL

**KALİPER
RULMAN YATAĞI (KAŞIK) L**
RH 2120



RADIAL ÖN

**KALİPER
RULMAN YATAĞI (KAŞIK)**
RH 2122



**KALİPER
RULMAN YATAĞI (KAŞIK) L**
RH 2043



**KALİPER
RULMAN YATAĞI (KAŞIK) R**
RH 2044



440 RENAULT - VOLVO - CARGO

**KALİPER
RULMAN YATAĞI (KAŞIK)**
RH 2039



**KALİPER
AYAR CİVATASI - R**
RH 2114



**KALİPER
AYAR ÇİVATASI - L**
RH 2113



VOLVO ÖN - R- L / ARKA - R

**KALİPER
AYAR MEKANİZMASI - R**
RH 2118



VOLVO ARKA - L

**KALİPER
AYAR MEKANİZMASI - L**
RH 2119

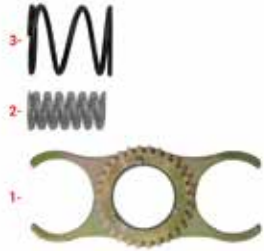

VOLVO

**KALİPER
AYAR DİŞLİ TUTUCU**
RH 2115



VOLVO YENİ MODEL 2008
SONRASI ÖN

**KALİPER
RULMAN YATAĞI (KAŞIK)**
RH 2034



RENAULT 420

**KALİPER KAPAK
MEKANİZMA AYAR SETİ**
RH 2224



RENAULT 440 - CARGO

**KALİPER KAPAK
MEKANİZMA AYAR SETİ**
RH 2225



**KALİPER AYAR ÇİVATASI
KİLİT SAÇI**
RH 2123



ROR DORSEY

**KALİPER RULMAN
YATAĞI (KAŞIK)**
RH 2038



RENAULT 420 22,5
KALİPER TAŞIYICI

RH 2320



RENAULT 440 22,5
KALİPER TAŞIYICI

RH 2321



VOLVO 22,5
KALİPER TAŞIYICI

RH 2319



D DUCO 22,5
KALİPER TAŞIYICI

RH 2324



VOLVO FH16
KALİPER TAŞIYICI

RH 2325



VOLVO ARKA SOL
FULL SET

KLP SET 2039



VOLVO ARKA SAĞ
FULL SET

KLP SET 2038

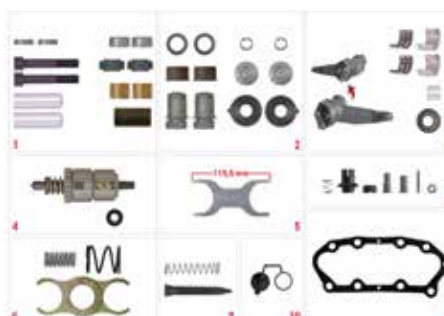

VOLVO ÖN
FULL SET

KLP SET 2037



MODUL GEN X

**KALİPER PERNO
BURC TAMİR TAKIMI**
RH 4024



**KALİPER
KOMPLE MEKANİZMA SETİ**
RH 4035



KISA PERNO 35x118,70
UZUN PERNO 35,50x86,75
MODUL T

**KALİPER PERNO
BURC TAMİR TAKIMI**
RH 6001



MODUL T

KALİPER SARI TAPA

RH 6007



KALİPER SİYAH TAPA

RH 6006



**KALİPER PLASTİK
MEKANİZMA DİŞLİSİ**

RH 6004



**KALİPER MEKANİZMA
SABİTLEME PLASTİĞİ**
RH 6010



**KALİPER AYAR SABİTLEME
PLASTİĞİ**
RH 6002



MODUL T
**KALİPER PLASTİK
DİŞLİ TAPA TK.**
RH 6026



**KALİPER MEKANİZMA
KOMPLE SET**
RH 6017



MODUL T
**KALİPER BALATA
TUTUCU LEVYE TAKIMI**
RH 6019



MODUL X GEN 2
BALATA TUTUCU
RH 4032



MODUL X GEN 2
FULL SET
KLP SET 4001



MODUL T
FULL SET
KLP SET 6001



FORD CARGO

AYAR CİVATASI

EF 101



FORD CARGO

TOZ LASTİK SİLİKON

EF 110



FORD CARGO

TAHRİK BURCU

EF 144



FORD CARGO

BASKI KELEPÇESİ

EF 226



FORD CARGO

YAYLI AYAR MANDALI

EF 401



FORD CARGO

KORUK KAMASI

EF 403



FORD CARGO

KORUK KAMASI

EF 423



PRO 522

KORUK KAMASI

EF 527



PRO 522

TOZ LASTİK SİLİKON

EF 531



BMC 522

FREN AYAR SETİ

EF 535



**AYAR MEKANİZMA
SAĞ D001**

RH 680.00



**AYAR MEKANİZMA
SOL D002**

RH 681.00



BMC FATİH

**PİNYON DİŞLİ
SAĞ**

RH 682.00



BMC FATİH

**PİNYON DİŞLİ
SOL**

RH 683.00



ÇAPRAZ MİL DİŞLİ

RH 684.00



**ELLE AYAR
ÇUBUK**

RH 685.00



**AYAR KİLİTLEME SACI
SAĞ**

RH 686.00



**AYAR KİLİTLEME SACI
SOL**

RH 687.00



BMC PRO
PİNYON DİŞLİ
SAĞ
RH 688.00



BMC PRO
PİNYON DİŞLİ
SOL
RH 689.00



AYAR ALÜMİNYUM TOZ
KAPAK
RH 690.00



SAKS FREN
İTİCİ PİM
RH 691.00



SAKS FREN
TUTUCU PİM D
RH 692.00



C YAY
RH 693.00



MANTAR CONTA
RH 694.00



İNCE DİŞLİ
DİŞLİ KAPAK
RH 695.00



TOZ LASTİK SİLİKON
RH 696.00



MERCEDES ARKA

YAY 001

81976100115 - 3469930310 - 3469930110



MERCEDES ÖN

YAY 0023469930210 - 81976100317
81976100118 - 6179930610

JUMBO DORSE

YAY 003

0 539746120



BMC FATİH - FORD CARGO

YAY 004

EF 124



26.230 MAN

YAY 005

84976100271



TIRSAN UZUN YAY 29 CM

YAY 006

TIRSAN SERTEL YAY 27 CM

YAY 007

KOL YAYI UZUN

YAY 008

0539726030 - 1447003700



KOL YAYI ORTA (STANDART)

YAY 009



KOL YAYI KISA

YAY 010



TIRSAN KISA YAY 24 CM

YAY 011



TIR ASKI YAY

YAY 012

339744060



BP DORSE (VABİS) BÜYÜK

YAY 013

0539746070



DORSE CİVATALI

YAY 014

1279502



BP ÇATAL DÜZ YAY

YAY 015



BP ÇATAL ÇENGELLİ YAY

YAY 016



SERİN DORSE EM

YAY 017



TIRSAN ORTA YAY 28M

YAY 018

0 539758030



ÖZKOÇ EM

YAY 019

OZK7102



DAF YM

YAY 020



VOLVO

YAY 021

1586683



MERCEDES AXOR Y.M. ARKA

ABS ÇEMBERİ SAC
AC 001

Referans No: 942 356 07 15
100 Diş - 154x175 / 197x16



MERCEDES ON E.M.

ABS ÇEMBERİ SAC
AC 002

Referans No: 9423340015
100 Diş - 160x188x11



MERCEDES AXOR Y.M. ON

ABS ÇEMBERİ SAC
AC 003

Referans No: 943 334 01 15
100 Diş - 140x170 / 178 x 14



SAF

ABS ÇEMBERİ SAC
AC 004

Referans No: 94029106300
90 Diş - Ø 116xØ 151 / Ø 160x19



DAF ARKA

ABS ÇEMBERİ SAC
AC 005

Referans No: 1805823 - 1391517
100 Diş - Ø 168xØ 183 / Ø 212x18



DAF ARKA

ABS ÇEMBERİ SAC KONİK
AC 006

Referans No: 1805824 - 1657638
100 Diş - Ø 168 x Ø 183 / Ø 212 x 18



BPW

ABS ÇEMBERİ SAC
AC 007

Referans No: 331008510
100 Diş - 125 x156 / 165 x 9



BPW

ABS ÇEMBERİ DOKUM
AC 008

Referans No: 331008510
100 Diş - 125 x156 / 165 x 9



VOLVO - RENAULT ARKA

ABS ÇEMBERİ DOKUM
AC 009

Referans No: 20424109
100 Diş - Ø 142.6 x Ø 164 x 7.75



FORD CARGO ARKA

ABS ÇEMBERİ

AC 010



FORD CARGO ÖN

ABS ÇEMBERİ

AC 011



RENAULT VOLVO

ABS ÇEMBERİ

AC 013



SAF 88

ABS ÇEMBERİ

AC 015



BP YENİ MODEL

ABS ÇEMBERİ

AC 016



ATEGO ARKA

ABS ÇEMBERİ

AC 017



SERTEL 168

ABS ÇEMBERİ

AC 018



YERLİ DİNGİL 170

ABS ÇEMBERİ

AC 019



SAF

DS 001

Referans No: BÜYÜK MODEL SAĞ



SAF

DS 002

Referans No: KÜÇÜK MODEL SAĞ



SAF

DS 003

Referans No: BÜYÜK MODEL SAĞ



SAF

DS 004

Referans No: KÜÇÜK MODEL SAĞ



BPW

DS 005

Referans No: ESKİ MODEL



BPW

DS 006

Referans No: YENİ MODEL



AXL

DS 007



SERTEL 12 TON

DS 008



OZKOC

DS 009



PIRLANTA 12 TON

DS 010



AYDIN

DS 011



BP

DS 012

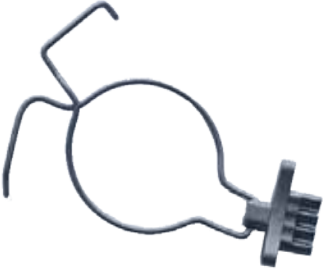

BP

DS 013



BÜYÜK

DS 014



KÜÇÜK

DS 015



BPW 115X2

PORYA KAPAĞI DIŞTAN DİŞLİ

PK 001

Referans No: 03.212.23.09.0



BPW 125X2

PORYA KAPAĞI DIŞTAN DİŞLİ

PK 003

Referans No:03.212.24.07.0



BPW 125X2

PORYA KAPAĞI İÇTEN DİŞLİ

PK 006

Referans No: 03.212.24.25.0



BPW 135X2

PORYA KAPAĞI İÇTEN DİŞLİ

PK 007

Referans No: 03.212.25.08.0



BPW 136x2,5

PORYA KAPAĞI İÇTEN DİŞLİ

PK 008



PIRLANTA 12 TON

PORYA KAPAĞI

PK 011



TRAX YENİ MODEL

PORYA KAPAĞI

PK 012



SMB 135X2

PORYA KAPAĞI

PK 013

Referans No:M044554 - M050872



SAF 131X37,5

PORYA KAPAĞI

PK 014

Referans No: 4 304 0093 00



SAF 151,3X52

PORYA KAPAĐI

PK 015

Referans No: 4 304 0102 00
4 304 0102 01 - 3 304 0102 01

AXL 136X2

PORYA KAPAĐI

PK 021

Referans No:



AXL 140X2

PORYA KAPAĐI

PK 022

Referans No:



SERTEL 123X2

PORYA KAPAĐI

PK 023

Referans No:



SERTEL 143X2

PORYA KAPAĐI

PK 024

Referans No:



SERTEL 153X2

PORYA KAPAĐI

PK 025

Referans No:



OZKOC 143X2

PORYA KAPAĐI

PK 026

Referans No:



AYDIN 140X2

PORYA KAPAĐI

PK 027

Referans No:



OSMAN KOC 145X2 K1

PORYA KAPAĐI

PK 028

Referans No:



SERIN 145X2

PORYA KAPAĐI
PK 031



Bertocco

HAKKIMIZDA

1986 yılında İzmir'de kurulan firmamız, sektördeki 35 yıllık deneyimi ile Treyler, Otobüs, Kamyon ve Tır fren sistemleri için yedek parça satışı yapmaktadır. Yurtiçinde ve dışında fren sistemleri üzerine üretim yapan konusunda lider firmaların bayiliğini yapmakta ve ayrıca kendi markaları altında üretim yaptırmaktadır.

35 yılı aşkın süredir sektörde devamlılığı sağlayan, tecrübesi ve bilgi birikimi ile fren sistemleri konusunda müşterileri için iyi bir tedarikçi olmanın gayreti içerisindeyiz.

Hedefimiz, Sürekli değişim halinde bulunan fren sistemleri sektöründe, ürün yelpazemizi, kalitemizi ve hizmetlerimizi geliştirerek müşterilerimiz için iyi bir çözüm ortağı olabilmektir.

ABOUT US

Our company was founded in 1986 in İzmir. We sell spare parts for Truck, Bus, Trailer and Semi-trailer with 35-years experience. We are authorized distributor for some well-known brand manufacturers for air brake system and distribute products manufactured under own registered brand - names.

We are in an endeavour being a supplier for our customers about air brake system with experience, knowledge and continuity throughout 35 years.

Our main goal is to be best partner for our customers and develop our product range, quality and services in the everchanging and ever-growing air brake system technology.

ÜRÜN GARANTİ ŞARTLARI

TEMMUZ 2021

Ürünlerimiz 'üretim hatalarına' karşı 1 ay süre ile garantilidir.

Garanti şartları aşağıdaki durumlarda geçersizdir:

1. 2 YIL ve daha eski ürünler. Ürünün üretim tarihi, metal etikette yazılıdır.
2. Araç hava tertibatında bulunan kurum, çamur, yağ, toz vs gibi maddelerin ürün içerisine girmesi
3. Uzun zaman kullanıldığını gösteren küflü ve paslı ürünler
4. Ürün portlarında kırılma, çatlama gibi montaj sırasında oluşan hasarlarda
5. Araç ile uyumu olmayan yanlış ürün seçiminde.

Ürün iadesi yapmadan önce gerekli olan, marka kontrolü, yıl kontrolü, yağ ve korozyon kontrolü yapıldıktan sonra iade edilmesini rica ederiz.

Saygılarımızla

auto brake

Bertocco



auto brake

Bertocco

www.autobrake.com.tr

Turkey

Discover
the potential

Izmir
öncülerin şehri

