

www.autobrake.com.tr

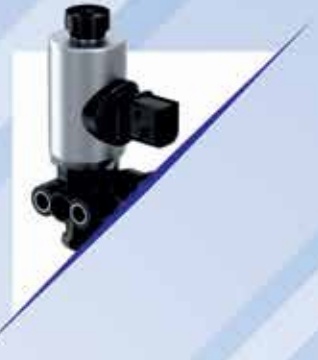

auto brake

Bertocco

ÜRÜN KATALOĞU
Product Catalogue

2023 - OCAK

İÇİNDEKİLER

Hava Tahliyeler	2-3
Altılı Dağıtıcı Ventiller	4
Çabuk Tahliye	5
Fren Pedal Merkezleri	6
Role Ventiller	7
Dörtlü Dağıtıcılar	8-9
Dorse Kumanda Ventilleri	10
Yük Ayar Ventilleri	11-12
Basınç Ayar Valfleri	13
Kasa Körük Ventilleri	14-15
Şanzuman Ventilleri	16
Vites Topuzları	17-18
Muhtelif Ventiller	19-20
El Fren Kolları	21-22
Fren Körükleri	23
Disk Fren Körükleri	24
Fren Diyafram Lastikleri	25
Ecas Sensor Ventilleri	26
Solenoid Valf	27
Abs Sensörleri	28-30
Balata Sensörleri	31-32
Müşür Ve Sensörler	33
Dorse Malzemeleri	34-35
Polyemit Fren Hortumları	36-37
Knorr Tipi Kaliper Grubu	38-45
Wabco Tipi Kaliper Grubu	46-51
Bpw Tipi Kaliper Grubu	52-53
Meritor Tipi Kaliper Grubu	54-58
Haldex Tipi Kaliper Grubu	59-60
Kamalı Fren Parçaları	61
Saks Fren Yedek Parçaları	62-63
Yaylar	64-65
Abs Çemberleri	66-68
Akson Dingil Somunları	69-70
Porya Kapakları	71-72

PNÖMATİK TEST TEZGAHI

TM-01

1. PNÖMATİK OLARAK VENTİL - VALF GURUBU BASINÇ VE KAÇAK TESTLERİ YAPABİLİR.
2. BOBİNLERİN ARIZA KONTROLÜNÜ YAPABİLİR.
3. EBS BEYİNLERİNİ KONTROL EDEBİLMEK İÇİN HARİCİ CİHAZ BAĞLAYABİLECEĞİNİZ SOKETLER VE FİŞLER HAZIRDIR.





MERCEDES 2521 - 3031

HAVA TAHLİYE

RH 101.00
Referans No:975 303 473 0



BMC - DODGE

GİZLİ TAHLİYE

RH 109.00
Referans No: 275508



MERCEDES 403 OTOBÜS

SU TAHLİYE

RH 150.00
Referans No: A0024328001



IVECO STRALİS / 10,5 BAR / FİLTRESİZ

KURUTUCULU TAHLİYE

RH 113.15
Referans No: LA 8606



MAN / 12,5 BAR / FİLTRESİZ

KURUTUCULU TAHLİYE

RH 113.72
Referans No: LA 8210



MERCEDES AXOR 4140
12,5 BAR / FİLTRESİZ

KURUTUCULU TAHLİYE

RH 114.00
Referans No: LA 9010-9034



8,1 BAR / FİLTRESİZ

KURUTUCULU TAHLİYE

RH 120.06
Referans No:432 410 102 0



12,5 BAR / FİLTRESİZ

KURUTUCULU TAHLİYE

RH 120.14
Referans No:432 410 004 0



MERCEDES AXOR / 12,5 BAR
FİLTRESİZ

KURUTUCULU TAHLİYE

RH 120.50
Referans No: 932 400 024 0



FORD CARGO 3230 / FİLTRESİZ

KURUTUCULU TAHLİYE

RH 120.60
Referans No: 432 415 022 0



IVECO / 12,5 BAR / FİLTRESİZ

KURUTUCULU TAHLİYE

RH 120.70
Referans No: 432 410 034 0



RENAULT / 12,5 BAR / FİLTRESİZ

KURUTUCULU TAHLİYE

RH 133.21
Referans No: LA 8044



FORD CARGO 1838 / FİLTRESİZ

KURUTUCULU TAHLİYE

RH 135.00
Referans No: ZB 4424



MERCEDES-IVECO-MAN-DAF
VOLVO-RENAULT

**SUSTURUCU FİLTRE
KÜÇÜK**

RH 725.00
Referans No: 432 407 070 0



MERCEDES-IVECO-MAN-DAF
VOLVO-RENAULT

**SUSTURUCU FİLTRE
BÜYÜK**

RH 725.01
Referans No: 432 407 015 0



MERCEDES AXOR
MÜŞÜRLÜ

ALTILI DAĞITICI VENTİL

RH 111.00
Referans No: 934 705 005 0



MERCEDES AXOR
MÜŞÜRSÜZ

ALTILI DAĞITICI VENTİL

RH 111.01
Referans No: 934 705 005 0



WABCO TİPİ

ALTILI DAĞITICI MÜŞÜR

RH 111.02
Referans No: 441 043 500 1



WABCO TİPİ

ALTILI DAĞITICI MÜŞÜR

RH 111.03
Referans No: 932 500 501 1



KNORR TİPİ

ALTILI DAĞITICI MÜŞÜR

RH 111.04
Referans No: K046313K50



DAF XF - CF EURO 3

ALTILI DAĞITICI VENTİL

RH 115.03
Referans No: AE 4528



IVECO STRALIS

ALTILI DAĞITICI VENTİL

RH 115.60
Referans No: AE 4560



MERCEDES AXOR 4140

ALTILI DAĞITICI VENTİL

RH 141.00
Referans No: AE 4800



M22 x 1,5 Diş

ÇABUK TAHLİYE VALFİ

RH 118.00
Referans No: 973 500 000 0



FORD CARGO
1/2 - 3/8

ÇABUK TAHLİYE VALFİ

RH 118.01
Referans No: 973 500 014 0



1/4 Diş

ÇABUK TAHLİYE VALFİ

RH 118.02
Referans No: 5050007



M16 x 1,5 Diş

ÇABUK TAHLİYE VALFİ

RH 118.03
Referans No: 973 500 006 0



1 GİRİŞ M22 x 1,5 Diş
2 ÇIKIŞ M16 x 1,5 Diş

ÇABUK TAHLİYE VALFİ

RH 118.04
Referans No:



M22 x 1,5 Diş

AYARLI ÇABUK TAHLİYE VALFİ

RH 118.05
Referans No: 975 001 000 0



MUHTELİF ARAÇLAR
8 DELİK = M16*1,5

FREN PEDAL VALFİ

RH 201.00
Referans No: 461 315 008 0



MUHTELİF ARAÇLAR
10 DELİK - 8 = M16*1,5 / 2 = M12*1,5

FREN PEDAL VALFİ

RH 201.01
Referans No: 461 315 042 0



FORD CARGO E.M.

FREN PEDAL VALFİ

RH 216.00
Referans No: APGA 6620



MAN

FREN PEDAL VALFİ

RH 224.00
Referans No: MB 4820



SCANIA 4 SERİ

FREN PEDAL VALFİ

RH 225.00
Referans No: 048 106 460 3000



MERCEDES AXOR 4140

FREN PEDAL VALFİ

RH 240.16
Referans No: 461 319 274 0



M16*1,5

ROLE VENTİL

RH 301.00
Referans No: 973 001 020 0



M22*1,5

ROLE VENTİL

RH 301.01
Referans No: 973 001 010 0



M22*1,5

ROLE VENTİL

RH 306.00
Referans No: 973 011 000 0



M22*1,5

ROLE VENTİL

RH 306.20
Referans No: 973 011 200 0



M22*1,5

ROLE VENTİL

RH 306.21
Referans No: 973 011 201 0



M22*1,5

ROLE VENTİL

RH 306.25
Referans No: 973 011 206 0



M22*1,5

ROLE VENTİL

RH 306.30
Referans No: 973 011 050 0



M22*1,5

ROLE VENTİL

RH 306.51
Referans No: 973 006 003 0



M22*1,5

ROLE VENTİL

RH 329.00
Referans No: AC 574 AXY



1 =M22*1,5 - 4 =M16*1,5

DÖRTLÜ DAĞITICI VENTİL

RH 312.06

Referans No: 934 702 300 0



7 DELİK
1 = M22*1,5 - 6 = M16*1,5 / 10 BAR

DÖRTLÜ DAĞITICI VENTİL

RH 319.00

Referans No: AE 4162



5 DELİK
1=M22*1,5 - 4=M16*1,5/10 BAR

DÖRTLÜ DAĞITICI VENTİL

RH 319.05

Referans No: AE 4158-4170



5 DELİK
5=M22*1,5

DÖRTLÜ DAĞITICI VENTİL

RH 319-30

Referans No: AE 4404



RENAULT

DÖRTLÜ DAĞITICI VENTİL

RH 319 40

Referans No: AE 4440



5 DELİK
1= M22*1,5 - 4=M16*1,5

DÖRTLÜ DAĞITICI VENTİL

RH 332.00

Referans No: 934 714 1250



FORD CARGO
1=1/2 - 4=3/8

DÖRTLÜ DAĞITICI VENTİL

RH 350.00

Referans No: 934 713 004 0



FORD CARGO 2520 / 2524

DÖRTLÜ DAĞITICI VENTİL

RH 390.00

Referans No: AE 4612



VOLVO 7 DELİK

DÖRTLÜ DAĞITICI VENTİL

RH 390.01

Referans No: 934 714 740 0



MAN 5 DELİK

DÖRTLÜ DAĞITICI VENTİL

RH 390.11

Referans No: AE 4609



RENAULT

DÖRTLÜ DAĞITICI VENTİL

RH 390.40

Referans No: AE 4605



M16*1,5 - AYARLI

DORSE KONTROL VENTİLİ

RH 316.11
Referans No: 973 002 501 0



M22*1,5

ACİL DURUM VALFİ

RH 317.00
Referans No: 971 002 150 0



M16*1,5

ACİL DURUM VALFİ

RH 317.01
Referans No: 971 002 152 0



MERCEDES 3031 M16*1,5

YÜK AYAR VENTİLİ

RH 321.01
Referans No: 475 710 020 0



FORD CARGO

YÜK AYAR VENTİLİ

RH 321.05
Referans No: 475 710 007 0



ÇEKİCİ İÇİN
M16*1,5

YÜK AYAR VENTİLİ

RH 321.10
Referans No: 475 711 108 0



MANUEL YÜK AYAR KOLU

RH 358.00
Referans No: 475 604 011 0



RENAULT
M22*1,5

DORSE KONTROL VENTİLİ

RH 318.01
Referans No: AC 598 C



MERCEDES AXOR E.M.

DORSE KONTROL VENTİLİ

RH 338.00
Referans No : 355094001 / 000 431 95 13



ÇEKİCİ İÇİN
M22*1,5

YÜK AYAR VENTİLİ

RH 321.11
Referans No: 475 711 126 0



MERCEDES AXOR Y.M.

YÜK AYAR VENTİLİ

RH 321.20
Referans No: 475 710 136 0



DORSE DENİZALTI VENTİL

RH 342.00
Referans No: 475 715 500 0



M16*1,5

DORSE KONTROL VENTİLİ

RH 353.01
Referans No: 973 009 010 0



M22*1,5

DORSE KONTROL VENTİLİ

RH 353.00
Referans No: 973 009 300 0



DORSE

ABS PARK BUTONU

RH 452.00
Referans No: 963 001 051 0



LSV KOLU

KIRKAYAK KALDIRMA KOLU

RH 722.00
Referans No : 433 302 016 0



LSV KOLU KISA

KIRKAYAK KALDIRMA KOLU

RH 722.01



LSV KOLU METAL UZUN

KIRKAYAK KALDIRMA KOLU

RH 723.00
Referans No :



LSV KOLU METAL KISA

KIRKAYAK KALDIRMA KOLU

RH 723.10
Referans No :



M22*1,5

TÜP AYAR REGÜLATÖRÜ

RH 314.00
Referans No: 434 100 124 0



M22*1,5

BASINÇ AYAR VALFİ

RH 352.10
Referans No: 475 010 301 0



M22*1,5

BASINÇ LİMİT VALFİ

RH 357.00
Referans No: 475 010 025 0



M16*1,5 / 3,5 - 4,5 BAR

BASINÇ LİMİT VALFİ

RH 363.00
Referans No: 475 015 400 0



M16*1,5 / 9,5 - 11 BAR

BASINÇ AYAR VALFİ

RH 363.10
Referans No: AC 156 C



M16*1,5 / 7,5 - 9,5 BAR

BASINÇ LİMİT VALFİ

RH 363.03
Referans No: 475 015 031 0



M22*1,5 / RENAULT / 8 - 10 BAR

BASINÇ AYAR VALFİ

RH 364.00
Referans No: AC 157 C



EBS

DİNGİL KALDIRMA VALFİ

RH 340.00
Referans No : 463 084 041 0



DORSE / M12*1,5

KASA KÖRÜK VENTİLİ

RH 345.11
Referans No:464 006 003 0



YAVRULU DORSE / M12*1,5

KASA KÖRÜK VENTİLİ

RH 345.15
Referans No:464 006 100 0



DAF - M12*1,5

KASA KÖRÜK VENTİLİ

RH 346.00
Referans No:SV 1294



MERCEDES-M12*1,5

SÜSPANSİYON VENTİLİ

RH 346.02
Referans No: SV 1310



M12*1,5

KASA KÖRÜK VENTİLİ

RH 346.07
Referans No: SV 1307



FORD CARGO - KIRKAYAK

KASA KÖRÜK VENTİLİ

RH 368.00
Referans No:1C442K433A2AN



DÜZ

DENGE VENTİL LASTİK

RH 345.10
Referans No:



PIPO

DENGE VENTİL LASTİK

RH 345.20
Referans No:

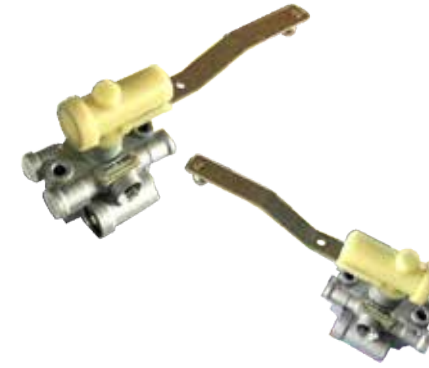

M12*1,5 / SAĞ

M12*1,5 / SOL

SÜSPANSİYON VENTİLİ

RH 310.00
Referans No: 0500 005 001

RH 310.01
Referans No: 0500 005 002

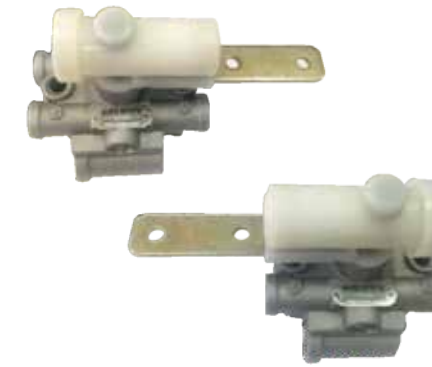

M12*1,5
KISA KOL SAĞ

M12*1,5
KISA KOL SOL

SÜSPANSİYON VENTİLİ

RH 310.02
Referans No: 0500 005 006

RH 310.03
Referans No: 0500 005 007



VOLVO FH-FM

KABİN SÜSPANSİYON VENTİLİ

RH 389.01
Referans No: 464 007 002 0



KNORR TİP PLASTİK

SÜSPANSİYON VENTİLİ

RH 346.15
Referans No:KN 27000



M12*1,5

SÜSPANSİYON VENTİLİ

RH 346.20
Referans No: SV 1280



SCANIA - M12*1,5

SÜSPANSİYON VENTİLİ

RH 346.24
Referans No: SV 1303



MERCEDES 1840 Y.M.

KABİN SÜSPANSİYON VENTİLİ

RH 389.02
Referans No: 464 007 011 0



RENAULT PREMIUM ARKA

KABİN SÜSPANSİYON VENTİLİ

RH 389.03
Referans No: 464 007 001 0



SCANIA 4 SERİ

KABİN SÜSPANSİYON VENTİLİ

RH 389.04
Referans No: 464 007 010 0



IVECO STRALIS

ŞANZUMAN STOP VENTİLİ

RH 347.40
Referans No: K018005N00



ZF 9S75 ŞANZUMAN ÇİVİLİ

ŞANZUMAN VENTİLİ

RH 354.00
Referans No: SV 3367



ZF 16S109 ŞANZUMAN

ŞANZUMAN VENTİLİ

RH 354.02
Referans No: ZF 0501 310 059



ZF 16S151 ŞANZUMAN

ŞANZUMAN KİBRİT KUTUSU

RH 354.03
Referans No: ZF 0501 208 629



ZF 9S75 ŞANZUMAN BİLYALI

ŞANZUMAN VENTİLİ

RH 354.05
Referans No: 6038 202 035 / 9P919135



SCANIA 4 SERİ

ŞANZUMAN VENTİLİ

RH 354.30
Referans No: 1334037



DAF Cf85 - XF95

ŞANZUMAN VENTİLİ

RH 354.34
Referans No: 1457276



ZF ŞANZUMAN

VİTES TOPUZU

RH 727.00
Referans No: 6005200241



ZF ŞANZUMAN

VİTES MANDALI

RH 354.04



FORD CARGO ÇİFT MANDAL

VİTES TOPUZU

RH 7897



FORD CARGO TEK MANDAL

VİTES TOPUZU

RH 6260



SCANIA 4 SERİ

VİTES TOPUZU

RH 2071
Referans No: 1362071



SCANIA R SERİ

VİTES TOPUZU

RH 1235
Referans No: 1441235



VOLVO

VİTES TOPUZU

RH 5854
Referans No: 1655854



SCANIA R SERİ 6+R+C

VİTES TOPUZU

RH 7377
Referans No: 1727377



VOLVO FH - FM

VİTES TOPUZU

RH 8052
Referans No: 20488052



RENAULT PREMIUM KERAX

VİTES TOPUZU
RH 9250

Referans No: 5010639250



MAN TGA VİDALI

VİTES MANDALI
RH 0043

Referans No: 81326200043



MAN F2000

VİTES TOPUZU
RH 6009

Referans No: 81970106009



REXROTH TİP

KİBRİT KUTUSU 3/2 VALF

RH 339.00

Referans No: 571 040 000 0



BMC - MERCEDES-IVECO-MAN

AYAK KUMANDA VALFİ

RH 347.00

Referans No: 463 013 0120



MERCEDES-IVECO-DAF-MAN
BMC-RENAULT

ÇAMUR TAKVİYE DÜĞMESİ

RH 359.00

Referans No: 463 036 000 0



HAVA HATTI FİLTRE

RH 383.00

Referans No: 432 500 020 0



FORD CARGO - BMC
3/8 REKORLU

İKİ YÖNLÜ VALF

RH 384.01

Referans No: 295036



MUHTELİF ARAÇLAR
M16*1,5

İKİ YÖNLÜ VALF

RH 384.03

Referans No: 295358



FORD-SCANIA-DAF-VOLVO
IVECO-BMC-MERCEDES

ABS MODÜLATÖRÜ

RH 423.00

Referans No: 472 195 018 0



RENAULT-DAF
3 FİŞLİ

ABS SELONİD VALF

RH 423.15

Referans No: 472 195 0150



MERCEDES-IVECO-MAN

ABS MODÜLATÖRÜ

RH 427.00

Referans No: BR 9150



1/2 - M22

TÜP ALTI ÇEK VALFİ

RH 700.00 / RH 701.00
Referans No:



PASOLU

ISITICI KABLO

RH 726.00
Referans No:



BAJONETLİ

ISITICI KABLO

RH 726.01
Referans No:



MERCEDES 403 OTOBÜS

EL FREN KOLU

RH 404.05
Referans No: 961 722 2840



BMC CARGO T BAŞLI
2 DELİK

EL FREN KOLU

RH 405.00
Referans No: 961 723 001 0



BMC CARGO
3 DELİK

EL FREN KOLU

RH 405.05
Referans No: 961 723 108 0



YANDAN 3 DELİK

EL FREN KOLU

RH 405.12
Referans No: 961 723 112 0



MERCEDES 1840
YANDAN 3 DELİK
ALTTAN 1 DELİK

EL FREN KOLU

RH 405.15
Referans No: 961 723 125 0



MERCEDES
6 DELİK

EL FREN KOLU

RH 405.20
Referans No: DPM 21AK
K038802N00



SCANIA

EL FREN KOLU

RH 405.40
Referans No: 961 723 122 0



FORD CARGO

EL FREN KOLU

RH 406.00
Referans No:APGA 6635



DORSE

RAMPA KOLU

RH 411.00
Referans No: 463 032 020 0



3 DELİK

EL FREN KOLU

RH 414.01
Referans No: DPM 95 AAX



TIRLAR İÇİN
MERCEDES AXOR

EL FREN KOLU

RH 415.00
Referans No: DPM 66A



KAMYONLAR İÇİN
MERCEDES AXOR

EL FREN KOLU

RH 415.01
Referans No: DPM 67 A



RENAULT
370 - 420

EL FREN KOLU

RH 416.00
Referans No: DPM 28 A



DAF

EL FREN KOLU

RH 439.00
Referans No: DPM 90 D



MAN TGA 18.410/430

EL FREN KOLU

RH 439.10
Referans No: DPM 90 CK



12*6200 / M16*1,5

İMDATLI FREN KÖRÜĞÜ

RH 852.00



24*30 D/D / M16*1,5

İMDATLI FREN KÖRÜĞÜ

RH 860.00



30*30 D/D / M16*1,5

İMDATLI FREN KÖRÜĞÜ

RH 861.00



30*30 D/P / M16*1,5

İMDATLI FREN KÖRÜĞÜ

RH 875.00



24*24 D/P / M16*1,5

**TAMİRSİZ
İMDATLI FREN KÖRÜĞÜ**

RH 872.08
Referans No:



24 TİP / M16*1,5

SERVİS FREN KÖRÜĞÜ

RH 832.00
Referans No:



30 TİP / M16*1,5

SERVİS FREN KÖRÜĞÜ

RH 833.00
Referans No:



16*24 D/D / M 16*1,5

DİSK FREN KÖRÜĞÜ
RH 821.00



16*24 D/D ÜZERİNDEKİ BORU

FREN KÖRÜK BORUSU
RH 821.10



16*24 D/P / M22*1,5

**TAMİRSİZ DİSK
İMDATLI FREN KÖRÜĞÜ**
RH 812.01
Referans No:



20*24 D/P / M22*1,5

**TAMİRSİZ DİSK
İMDATLI FREN KÖRÜĞÜ**
RH 815.01
Referans No:



24*24 D/P / M22*1,5

**TAMİRSİZ DİSK
İMDATLI FREN KÖRÜĞÜ**
RH 816.01
Referans No:925 481 270 0



16 TİP / M 22*1,5 / 2 Delik

**DİSK SERVİS
FREN KÖRÜĞÜ**
RH 880.15
Referans No:



20 TİP / M22*1,5
2 Delik

**DİSK SERVİS
FREN KÖRÜĞÜ**
RH 881.00
Referans No:



24 TİP / M22*1,5
2 Delik

**DİSK SERVİS
FREN KÖRÜĞÜ**
RH 882.00
Referans No:



**9 TİP
DİYAFRAM LASTİĞİ STD**
RH 890.01



**12 TİP
DİYAFRAM LASTİĞİ STD**
RH 890.02



**16 TİP
DİYAFRAM LASTİĞİ STD**
RH 890.03



**20 TİP
DİYAFRAM LASTİĞİ STD**
RH 890.04



**24 TİP
DİYAFRAM LASTİĞİ STD**
RH 890.05



**30 TİP
DİYAFRAM LASTİĞİ STD**
RH 890.06



**36 TİP
DİYAFRAM LASTİĞİ STD**
RH 890.08



**12 TİP
DİYAFRAM LASTİĞİ DERİN**
RH 891.02



**16 TİP
DİYAFRAM LASTİĞİ DERİN**
RH 891.03



**20 TİP
DİYAFRAM LASTİĞİ DERİN**
RH 891.04



**24 TİP
DİYAFRAM LASTİĞİ DERİN**
RH 891.05



**30 TİP
DİYAFRAM LASTİĞİ DERİN**
RH 891.06



**27 TİP
DİYAFRAM LASTİĞİ DERİN**
RH 891.07



**36 TİP
DİYAFRAM LASTİĞİ DERİN**
RH 891.08



MAN

ECAS SEVİYE VENTİLİ

RH 442.02

Referans No: 441 050 011 0



SCANIA

ECAS SEVİYE VENTİLİ

RH 442.04

Referans No: 1889797



BMC

ECAS SEVİYE VENTİLİ

RH 442.08

Referans No: 441 050 100 0

MERCEDES-IVECO
STRALIS**ECAS SEVİYE VENTİLİ**

RH 442.10

Referans No: 441 050 120 0

MERCEDES
AXOR**ECAS SEVİYE VENTİLİ**

RH 442.11

Referans No: 441 050 121 0



MERCEDES AROCS

ECAS SEVİYE VENTİLİ

RH 442.16

Referans No: 441 050 203 0



CARGO-BMC

SELONOİD VALF

RH 450.00

Referans No: 472 170 600 0



MERCEDES AXOR Y.M.

SELONOİD VALF

RH 451.00

Referans No: 472 170 606 0

**SELONOİD VALF**

RH 454.00

Referans No: 472 172 901 0



MERCEDES AXOR Y.M.

SELONOİD VALF

RH 455.00

Referans No: 472 170 001 0



MERCEDES AXOR E.M.

SELONOİD VALF

RH 456.00

Referans No: 472 070 639 0



BMC - DAF

SELONOİD VALF

RH 457.00

Referans No: 472 173 700 0



MERCEDES TRAVEGO - NEOPLAN

SELONOİD VALF

RH 458.00

Referans No: 472 176 316 0



DAF

SELONOİD VALF

RH 459.00

Referans No: 472 072 6280

L



KAMPANA FREN İÇİN

ABS SENSÖR 40 CM.RH 730.00
Referans No: 441 032 808 0

L



KAMPANA FRENLER İÇİN

ABS SENSÖR 100 CM.RH 732.00
Referans No: 441 032 809 0

L



KAMPANA FRENLER İÇİN

ABS SENSÖR 200 CM.RH 733.00
Referans No: 441 032 8230

DÜZ

MERCEDES
DİSK FREN İÇİN**ABS SENSÖR 35 CM.**RH 734.00
Referans No: 441 032 905 0

DÜZ



DİSK FREN İÇİN

ABS SENSÖR 250 CM.RH 736.00
Referans No: 441 032 920 0

DÜZ

**BAĞLANTI KABLOSU 380 CM.**RH 740.00
Referans No: 449 712 038 0

WABCO TİPİ

EBS ARA UZATMA KABLOSU 300 CM.RH 743.00
Referans No: 449 723 030 0

KNORR TİPİ - 400 CM

EBS ARA UZATMA KABLOSURH 743.10
Referans No: K027832

L

IVECO (SOKETLİ)
STRALIS**ABS SENSÖR 200 CM.**RH 744.00
Referans No: 441 032 8580

L



MERCEDES - AXOR 3028 ARKA SOL

ABS SENSÖR 51 CMRH 748.00
Referans No: 655 540 0817

L



MERCEDES - AXOR 3028 ARKA SAĞ

ABS SENSÖR 51 CMRH 749.00
Referans No: 655 540 0717

DÜZ



SCANIA R SERİ ARKA SAĞ

ABS SENSÖRRH 750.00
Referans No: 1892050

DÜZ



SCANIA R SERİ ARKA SOL

ABS SENSÖRRH 751.00
Referans No: 1892049

L



MAN F2000 ARKA SOL

ABS SENSÖRRH 755.00
Referans No: 81271206067

L



MAN F2000 ARKA SAĞ

ABS SENSÖRRH 756.00
Referans No: 81271206068

DÜZ



MAN - TGL - TGM ARKA SAĞ

ABS SENSÖR 300 CMRH 757.00
Referans No: 81271206219

DÜZ



MAN - TGL - TGM ARKA SOL

ABS SENSÖR 300 CMRH 757.10
Referans No: 81271206218

DÜZ



MAN - TGL - TGS - TGX ARKA SOL

ABS SENSÖR 205 CMRH 775.00
Referans No: 81271206119

DÜZ

RENAULT - SCANIA
SOKETLİ SAĞ - SOL**ABS SENSÖR 265 CM.**RH 745.00
Referans No: 441 032 386 0 / 70

DÜZ

RENAULT - SCANIA
SOKETLİ SAĞ - SOL**ABS SENSÖR 180 CM.**RH 746.00
Referans No: 441 032 900 0

L

RENAULT - SCANIA
SOKETLİ SAĞ - SOL**ABS SENSÖR 265 CM.**RH 747.00
Referans No: 5010 422 021 / 22

L



MERCEDES - AXOR 3028 ARKA SOL

ABS SENSÖR 51 CMRH 748.00
Referans No: 655 540 0817

L



MERCEDES - AXOR 3028 ARKA SAĞ

ABS SENSÖR 51 CMRH 749.00
Referans No: 655 540 0717

DÜZ



SCANIA R SERİ ARKA SAĞ

ABS SENSÖRRH 750.00
Referans No: 1892050

DÜZ



SCANIA R SERİ ARKA SOL

ABS SENSÖRRH 751.00
Referans No: 1892049

L



MAN F2000 ARKA SOL

ABS SENSÖRRH 755.00
Referans No: 81271206067

L



MAN F2000 ARKA SAĞ

ABS SENSÖRRH 756.00
Referans No: 81271206068

DÜZ



MAN - TGL - TGM ARKA SAĞ

ABS SENSÖR 300 CMRH 757.00
Referans No: 81271206219

DÜZ



MAN - TGL - TGM ARKA SOL

ABS SENSÖR 300 CMRH 757.10
Referans No: 81271206218

DÜZ



MAN - TGL - TGS - TGX ARKA SOL

ABS SENSÖR 205 CMRH 775.00
Referans No: 81271206119

DÜZ

RENAULT - SCANIA
SOKETLİ SAĞ - SOL**ABS SENSÖR 265 CM.**RH 745.00
Referans No: 441 032 386 0 / 70

DÜZ

RENAULT - SCANIA
SOKETLİ SAĞ - SOL**ABS SENSÖR 180 CM.**RH 746.00
Referans No: 441 032 900 0

L

RENAULT - SCANIA
SOKETLİ SAĞ - SOL**ABS SENSÖR 265 CM.**RH 747.00
Referans No: 5010 422 021 / 22

DÜZ



MAN - TGL - TGM ARKA SAĞ

ABS SENSÖR 300 CMRH 757.00
Referans No: 81271206219

DÜZ



MAN - TGL - TGM ARKA SOL

ABS SENSÖR 300 CMRH 757.10
Referans No: 81271206218

DÜZ



MAN - TGL - TGS - TGX ARKA SOL

ABS SENSÖR 205 CMRH 775.00
Referans No: 81271206119

DÜZ

RENAULT - SCANIA
SOKETLİ SAĞ - SOL**ABS SENSÖR 265 CM.**RH 745.00
Referans No: 441 032 386 0 / 70

DÜZ

RENAULT - SCANIA
SOKETLİ SAĞ - SOL**ABS SENSÖR 180 CM.**RH 746.00
Referans No: 441 032 900 0

L

RENAULT - SCANIA
SOKETLİ SAĞ - SOL**ABS SENSÖR 265 CM.**RH 747.00
Referans No: 5010 422 021 / 22

DÜZ



MAN - TGL - TGM ARKA SAĞ

ABS SENSÖR 300 CMRH 757.00
Referans No: 81271206219

DÜZ



MAN - TGL - TGM ARKA SOL

ABS SENSÖR 300 CMRH 757.10
Referans No: 81271206218

DÜZ



MAN - TGL - TGS - TGX ARKA SOL

ABS SENSÖR 205 CMRH 775.00
Referans No: 81271206119

DÜZ

RENAULT - SCANIA
SOKETLİ SAĞ - SOL**ABS SENSÖR 265 CM.**RH 745.00
Referans No: 441 032 386 0 / 70

DÜZ

RENAULT - SCANIA
SOKETLİ SAĞ - SOL**ABS SENSÖR 180 CM.**RH 746.00
Referans No: 441 032 900 0

L

RENAULT - SCANIA
SOKETLİ SAĞ - SOL**ABS SENSÖR 265 CM.**RH 747.00
Referans No: 5010 422 021 / 22

DÜZ



MAN - TGL - TGM ARKA SAĞ

ABS SENSÖR 300 CMRH 757.00
Referans No: 81271206219

DÜZ



MAN - TGL - TGM ARKA SOL

ABS SENSÖR 300 CMRH 757.10
Referans No: 81271206218

DÜZ



MAN - TGL - TGS - TGX ARKA SOL

ABS SENSÖR 205 CMRH 775.00
Referans No: 81271206119

DÜZ

RENAULT - SCANIA
SOKETLİ SAĞ - SOL**ABS SENSÖR 265 CM.**RH 745.00
Referans No: 441 032 386 0 / 70

DÜZ

RENAULT - SCANIA
SOKETLİ SAĞ - SOL**ABS SENSÖR 180 CM.**RH 746.00
Referans No: 441 032 900 0

L

RENAULT - SCANIA
SOKETLİ SAĞ - SOL**ABS SENSÖR 265 CM.**RH 747.00
Referans No: 5010 422 021 / 22

DÜZ



MAN - TGL - TGM ARKA SAĞ

ABS SENSÖR 300 CMRH 757.00
Referans No: 81271206219

DÜZ



MAN - TGL - TGM ARKA SOL

ABS SENSÖR 300 CMRH 757.10
Referans No: 81271206218

DÜZ



MAN - TGL - TGS - TGX ARKA SOL

ABS SENSÖR 205 CMRH 775.00
Referans No: 81271206119

DÜZ

RENAULT - SCANIA
SOKETLİ SAĞ - SOL**ABS SENSÖR 265 CM.**RH 745.00
Referans No: 441 032 386 0 / 70

DÜZ

RENAULT - SCANIA
SOKETLİ SAĞ - SOL**ABS SENSÖR 180 CM.**RH 746.00
Referans No: 441 032 900 0



**KALİPER KAPAK ARA
KABLO 3 FİŞLİ**
RH 779.00
Referans No: 449 758 0220



SCANIA
**KALİPER KAPAK ARA
KABLO 3 FİŞLİ**
RH 779.10
Referans No: 1884529

DÜZ



MERCEDES AROCS ARKA SAĞ
ABS SENSÖR 130 CM
RH 780.00
Referans No: A0075422018

DÜZ



MERCEDES AROCS ARKA SOL
ABS SENSÖR 145 CM
RH 780.10
Referans No: A0075422118

L



MAN TGS - TGX ÖN SAĞ
ABS SENSÖR 150 CM
RH 783.00
Referans No: 81271206176

L



MAN TGS - TGX ÖN SOL
ABS SENSÖR 150 CM
RH 783.10
Referans No: 81271206177

L



MAN TGS - TGX ÖN SOL
ABS SENSÖR 180 CM
RH 784.00
Referans No: 81271206125

L



MAN TGS - TGX ÖN SAĞ
ABS SENSÖR 180 CM
RH 784.10
Referans No: 8127 1206 126

L



FORD CARGO ARKA SOL Y.M.
ABS SENSÖR 265 CM.
RH 782.00
Referans No: 4410351270

L



FORD CARGO ARKA SAĞ Y.M.
ABS SENSÖR 51 CM
RH 782.10
Referans No: 4410351290

L



MERCEDES AROCS ÖN
ABS SENSÖR 51 CM
RH 780.20
Referans No: A0085420018



MAN TGA ARKA-SOL
BALATA SENSÖRÜ
RH 761.00
Referans No: 81259376041



MAN TGA ARKA-SAĞ
BALATA SENSÖRÜ
RH 761.10
Referans No: 81253760044



VOLVO FH - FM ARKA SOL
BALATA SENSÖRÜ
RH 763.00
Referans No: 20928541



VOLVO FH - FM ARKA SAĞ
BALATA SENSÖRÜ
RH 763.10
Referans No: 21390374



RENAULT PREMIUM DXI ARKA SAĞ
BALATA SENSÖRÜ
RH 767.10
Referans No: 7420928553



RENAULT PREMIUM DXI ÖN SOL
BALATA SENSÖRÜ
RH 766.00
Referans No: 7420928559



RENAULT PREMIUM DXI ÖN SAĞ
BALATA SENSÖRÜ
RH 766.10
Referans No: 7420528560



RENAULT PREMIUM DXI ARKA SOL
BALATA SENSÖRÜ
RH 767.00
Referans No: 7420928552



VOLVO FH - FM ÖN
BALATA SENSÖRÜ
RH 768.00
Referans No: 20928533



VOLVO FH - FM ARKA

BALATA SENSÖRÜRH 768.10
Referans No: 20928532

RENAULT PREMIUM ÖN SAĞ

BALATA SENSÖRÜRH 772.10
Referans No: 5001856032

RENAULT PREMIUM ARKA SAĞ

BALATA SENSÖRÜRH 773.10
Referans No: 5001856034

RENAULT PREMIUM ÖN SOL

BALATA SENSÖRÜRH 772.00
Referans No: 5001856031RENAULT PREMIUM ARKA SOL
RENAULT ARKA SOL**BALATA SENSÖRÜ**RH 773.00
Referans No: 5001856033VOLVO FH4
RENAULT 460 T KABİN**BALATA SENSÖRÜ**RH 781.00
Referans No: 7421296869VOLVO
RENAULT 460 T KABİN**BALATA SENSÖRÜ**RH 781.10
Referans No: 7421296868

MERCEDES AXOR

VOLAN SENSÖRÜRH 3120
Referans No: 0011533120

MERCEDES

KİLOMETRE MÜŞÜR SOKETİRH 726.02
Referans No: 3565400381

MERCEDES - FORD

**SÜSPANSİYON
KÖRÜK MÜŞÜRÜ**RH 290.00
Referans No: 4410441010



MUHTELİF

**KABİN TEMİZLEME
HORTUMU**

46071



MERCEDES ATEGO - AXOR JACKLI

**KABİN TEMİZLEME
HORTUMU**

46072



**DORSE HAVA
HORTUMU**

49307



4,5 Mt.

**7'Lİ EBS DORSE
ELEKTRİK KABLOSU**

030-171



4,5 Mt.

**15'Lİ EBS DORSE
ELEKTRİK KABLOSU**

030-181



4,5 Mt.

**(15-7x2) EBS DORSE
ELEKTRİK KABLOSU**

030-191PM



4,5 Mt. Dişi

**N TİPİ 7'Lİ DORSE
ELEKTRİK KABLOSU**

030-201



4,5 Mt. ERKEK

**S TİPİ 7'Lİ DORSE
ELEKTRİK KABLOSU**

030-211



SARI KIRMIZI M22 x 1,5

**DORSE HAVA KAPLİNİ
SİBOPLU**

RH 710.00



SARI KIRMIZI M16 x 1,5

**DORSE HAVA KAPLİNİ
SİBOPLU**

RH 710.01



SARI KIRMIZI M22 x 1,5

**DORSE HAVA KAPLİNİ
SİBOPSUZ**

RH 712.00



SARI KIRMIZI M16 x 1,5

**DORSE HAVA KAPLİNİ
SİBOPSUZ**

RH 712.01



YM

DORSE HAVA KAPLİNİ

RH 714.00

Referans No: KU-1400-1410



STANDART

KAPLİN LASTİĞİ

RH 715.00



YM

KAPLİN LASTİĞİ

RH 715.10



6*4(100 METRE)

POLYEMİT HORTUM
RH 785.00



8*6 (100 METRE)

POLYEMİT HORTUM
RH 786.00



10*8(100 METRE)

POLYEMİT HORTUM
RH 787.00



12*9 (100 METRE)

POLYEMİT HORTUM
RH 788.00



15X12 (50 METRE)

POLYEMİT HORTUM
RH 789.00



16X12 (50 METRE)

POLYEMİT HORTUM
RH 790.00



9X6 (100 METRE)

POLYEMİT HORTUM
RH 791.00



51 CM

FREN HORTUMU YAYLI
K 22201



59 CM

FREN HORTUMU YAYLI
K 22202



67 CM

FREN HORTUMU YAYLI
K 22203



76 CM

FREN HORTUMU YAYLI
K 22207



MERCEDES SEGMANLI

FREN HORTUMU
K 50602
Referans No: A0004203048



MERCEDES

FREN HORTUMU YAYLI
K 50603



FORD CARGO

FREN HORTUMU
K 90074



FORD CARGO

FREN HORTUMU
K 90243



ESKİ MODEL

KALİPER AYAR TAŞIYICI
KLP 1032



ESKİ MODEL

KALİPER AYAR CİVATASI
KLP 1008



69 mm

KALİPER AYAR TOZ LASTİK ŞAPKA TAKIMI
KLP 1038



69 mm

KALİPER AYAR TOZ LASTİK ŞAPKA TAKIMI
KLP 1127



74 mm

KALİPER AYAR TOZ LASTİK ŞAPKA TAKIMI
KLP 1015



74 mm

KALİPER AYAR TOZ LASTİK ŞAPKA TAKIMI
KLP 1016



ANAHTAR BAŞLI

KALİPER AYAR MEKANİZMASI
KLP 1029



12.160 / 12.180 MAN

KALİPER AYAR MEKANİZMASI
KLP 1064



YILDIZ BAŞLI

KALİPER AYAR MEKANİZMASI
KLP 1209



KALİPER AYAR MEKANİZMA ZİNCİRİ
KLP 1031



ORTA MODEL

KALİPER AYAR TAŞIYICI
KLP 1041



Kısa Pim 34x80
Uzun Pim 36x145

KALİPER PERNO BURÇ TAMİR TAKIMI
KLP 1002

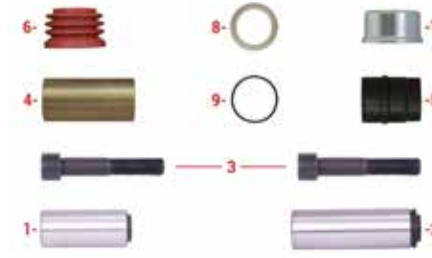

Kısa Pim 34x80
Uzun Pim 36x113,70

KALİPER PERNO BURÇ TAMİR TAKIMI
KLP 1027



Kısa Pim 34x80
Uzun Pim 36x135

KALİPER PERNO BURÇ TAMİR TAKIMI
KLP 1025



Uzun Tip

KALİPER METALLİ KAUCUK BURÇ
KLP 1522



MERCEDES - MAN - IVECO
DORSEY

KALİPER SABİT AYAR
KLP 1030



KISA TİP

KALİPER METALLİ KAUCUK BURÇ
KLP 1523



KALİPER PERNO TOZ KEÇESİ
KLP 1531



PERNO 32x80

**KALİPER PERNO BURÇ
TAMİR TAKIMI 1/2**
KLP 1090



KISA PERNO 32x80
UZUN PERNO 36x113,70

**KALİPER PERNO
BURÇ TAMİR TAKIMI**
KLP 1040



PERNO 32x80

**KALİPER PERNO
BURÇ TAMİR TAKIMI 1/2**
KLP 1205



KISA PERNO 32x80
UZUN PERNO 36x113,70

**KALİPER PERNO
BURÇ TAMİR TAKIMI**
KLP 1039



KALİPER SAÇ KAPAK

KLP 1045



YENİ MODEL

KALİPER SAÇ KAPAK

KLP 1046



YENİ MODEL

KALİPER AYAR TAŞIYICI

KLP 1042



TIRNAKLI

**KALİPER
YARIM AY RULMAN TAKIMI**

KLP 1005



YENİ MODEL

**KALİPER
YARIM AY RULMAN TAKIMI**

KLP 1069



KISA PERNO 32x80
UZUN PERNO 36x113,70

**KALİPER PERNO BURÇ
TAMİR TAKIMI**
KLP 1184



SENSÖRSÜZ KAPAK

KALİPER ZİNCİR KAPAĞI

KLP 1019



3 FİŞLİ MERCEDES

**KALİPER ZİNCİR KAPAĞI
SENSÖRLÜ**

KLP 1070



2 FİŞLİ MERCEDES

**KALİPER ZİNCİR KAPAĞI
SENSÖRLÜ**

KLP 1033



3 FİŞLİ MAN

**KALİPER ZİNCİR KAPAĞI
SENSÖRLÜ**

KLP 1074



12.180 MAN
UZUN PERNO: 30x99
KISA PERNO: 29,70x71,50

**KALİPER
PERNO BURÇ TAMİR TAKIMI**
KLP 1173



12.160 MAN

**KALİPER
YARIM AY RULMAN TAKIMI**

KLP 1168



SCANIA R 420

UZUN PERNO: 36x113,70
KISA PERNO: 32x84

**KALİPER PERNO
BURÇ TAMİR TAKIMI**

KLP 1061



**KALİPER BALATA
TUTUCU LEVYE TAKIMI**

KLP 1060



0 - 114 MM

**KALİPER RULMAN
YATAĞI (KAŞIK)**
KLP1035



0 - 127 MM

**KALİPER RULMAN
YATAĞI (KAŞIK)**
KLP 1171



12 - 122 MM

**KALİPER RULMAN
YATAĞI (KAŞIK)**
KLP 1206



0 - 124 MM

**KALİPER RULMAN
YATAĞI (KAŞIK)**
KLP 1043

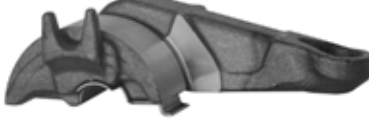

0 - 113 MM

**KALİPER RULMAN
YATAĞI (KAŞIK)**
KLP 1044



12 - 122 MM

**KALİPER RULMAN
YATAĞI (KAŞIK)**
KLP 1176



0 - 113 MM

**KALİPER RULMAN
YATAĞI (KAŞIK) BİLYALI**
KLP 1178



12 - 122 MM

**KALİPER RULMAN
YATAĞI (KAŞIK) BİLYALI**
KLP 1179



**KALİPER YARIM
AY RULMAN TAKIMI**
KLP 1168



YENİ MODEL

KALİPER AYAR CİVATASI
KLP 1009



KALİPER SABİT AYAR

KLP 1105



SCANIA 2 Fişli

**KALİPER ZİNCİR KAPAĞI
SENSÖRLÜ**
KLP 1021



SCANIA 3 Fişli

**KALİPER ZİNCİR KAPAĞI
SENSÖRLÜ**
KLP 1071



AXOR 22,5

KALİPER TAŞIYICI
KLP 1215



AXOR EM 22,5

KALİPER TAŞIYICI
KLP 1231



4140 ARKA 22,50

KALİPER TAŞIYICI
KLP 1235



AXOR YENİ MODEL

**KALİPER
FULL SET**
KLP SET 1009



AXOR

**KALİPER
FULL SET**
KLP SET 1008



DORSE

**KALİPER
FULL SET**
KLP SET 1016



SENSÖRSÜZ

**KALİPER ZİNCİR KAPAĞI
ALÜMİNYUM**
KLP 1089



KISA PERNO : 32*80,
UZUN PERNO 36*103

**KALİPER PERNO
BURÇ TAMİR TAKIMI**
KLP 1091



32*84

PERNO
KLP 1510



40X36X82

SARI BURÇ
KLP 1521



40X14,5

KALİPER TAPA
KLP 1543



OTOBUS TİPİ

**KALİPER RULMAN YATAĞI
(KAŞIK)**
KLP 1190



SK7 22,5 TİP

**KALİPER
TAŞIYICI**
KLP 1220



DAF 22,5 TİP

**KALİPER
TAŞIYICI**
KLP 1241



12.160 MAN TGL SET

**KALİPER
FULL SET**
KLP SET 1001



12.180 MAN TGL SET

**KALİPER
FULL SET**
KLP SET 1002



MERCEDES ACTROS / BP YENİ MODEL

**KALİPER
FULL SET**
KLP SET 1006



AXOR 4140 YENİ MODEL ÖN

**KALİPER
TAŞIYICI**
KLP 1254

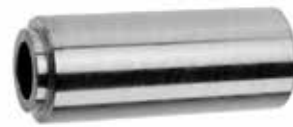

32*80

PERNO
KLP 1501



36*113,70

PERNO
KLP 1505



YENİ MODEL

**KALİPER
SABİT AYAR**
KLP 1222



**KALİPER
TAPA KİTİ**
KLP 1068



ORJINAL TIP

**KALİPER
OTOMATİK AYAR**
KLP 1101



KISA PERNO 30x77,30
UZUN PERNO 30x91
12.153 MAN

KALİPER PERNO BURÇ TAMİR TAKIMI
KLP 3143



SAF / 12.153 MAN

KALİPER TOZ LASTİĞİ
KLP 3531



KISA PERNO 37,70x76
UZUN PERNO 38x118
SAF

KALİPER PERNO BURÇ TAMİR TAKIMI
KLP 3156



12.153 MAN

KALİPER AYAR CİVATASI
KLP 3146



SAF

KALİPER AYAR CİVATASI
KLP 3165



12.153 MAN

KALİPER BALATA PLEYTİ R
KLP 3152



12.153 MAN

KALİPER BALATA PLEYTİ L
KLP 3151



SAF

KALİPER BALATA PLEYTİ R
KLP 3162



SAF

KALİPER BALATA PLEYTİ L
KLP 3161



SAF - 12.153 MAN

KALİPER YARIM AY RULMAN TAKIMI
KLP 3148



KISA PERNO 37,70x76
UZUN PERNO 38x118
RENAULT

KALİPER PERNO BURÇ TAMİR TAKIMI
KLP 3201



12.153 MAN

KALİPER AYAR TAŞIYICI MEKANİZMA SETİ
KLP 3172



SAF

KALİPER AYAR TAŞIYICI MEKANİZMA SETİ
KLP 3173

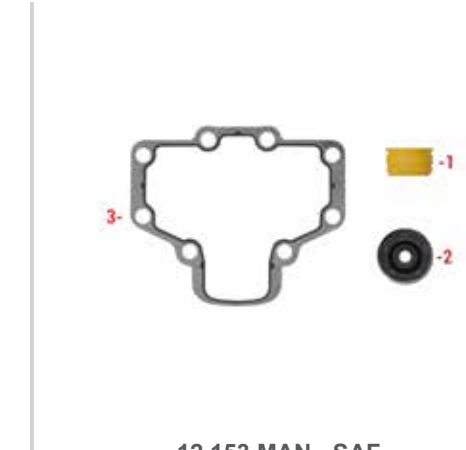

12.153 MAN - SAF

KALİPER CONTA KEÇE TAKIMI
KLP 3150



12.153 MAN - SAF

KALİPER RULMAN YATAĞI (ÇATAL)
KLP 3149



SAF ORTA MODEL

KALİPER BALATA PLEYTİ R
KLP 3159



SAF ORTA MODEL

KALİPER BALATA PLEYTİ L
KLP 3158



MAXX 22 - MN TGX

KALİPER AYAR MEKANİZMA SETİ
KLP 3141



MAXX 22 - MN TGX - AROCS

**KALİPER
ELLE AYAR DİŞLİSİ**
KLP 3137



KISA PERNO 37,70x76
UZUN PERNO 38x118
MAXX 22 - MN TGX - AROCS

**KALİPER PERNO
BURC TAMİR TAKIMI**
KLP 3140



MAXX 22 - MN TGX

**KALİPER
RULMAN YATAĞI (KAŞIK)**
KLP 3131

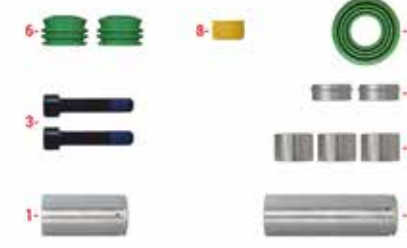

KISA PERNO 37,70x76
UZUN PERNO 38x63/118
MAXX22 T - SCHMITZ DORSE

**KALİPER PERNO BURÇ
TAMİR TAKIMI**
KLP 3100



MAXX22 - SCHMITZ DORSEY

**KALİPER AYAR TAŞIYICI
MEKANİZMA SETİ**
KLP 3101



MAXX22 - SCHMITZ DORSE

KALİPER SAÇ KAPAK
KLP 3103



MAXX 22 - MN TGX - AROCS

KALİPER SAÇ KAPAK
KLP 3138



MAXX 22 - MN TGX - AROCS

**KALİPER YARIM AY
RULMAN TAKIMI**
KLP 3135



MAXX 22 - MN TGX - AROCS

**KALİPER BALATA PLEYTİ
R**
KLP 3128



MAXX22 - SCHMITZ DORSEY

**KALİPER RULMAN
YATAĞI (KAŞIK)**
KLP 3102



MAXX 22 - AROCS

**KALİPER SENSORLU
KAPAK**
KLP 3190



MAXX 22 - AROCS

**KALİPER RULMAN
YATAĞI (KAŞIK)**
KLP 3126



MAXX 22 - MN TGX - AROCS

**KALİPER BALATA PLEYTİ
L**
KLP 3129



MAXX 22 - MN TGX - AROCS

**KALİPER
AYAR CİVATASI**
KLP 3588



MAXX22 - MN TGX

**KALİPER SENSÖRLÜ
KAPAK**
KLP 3267



MAXX 22 - AROCS - MN TGS

**KALİPER AYAR TAŞIYICI
MEKANİZMA SETİ**
KLP 3142



SAĞ 19,5

KALİPER TAŞIYICI
KLP 3273



SOL 19,5

KALİPER TAŞIYICI
KLP 3274



RENAULT MIDLUM

**KALİPER RULMAN YATAĞI
(KAŞIK)**
KLP 3181



AROCS SAĞ

FULL SET

KLP SET 3013



AROCS SOL

FULL SET

KLP SET 3014



RENAULT MIDLUM 22-2

**KALİPER
FULL SET**
KLP SET 3007



PAN 17 TİP 17,5 SOL

**KALİPER
TAŞIYICI**
KLP 3260



MAXX 22 TİP SAĞ

**KALİPER
TAŞIYICI**
KLP 3263



PAN TİP 17,5 SAĞ

**KALİPER
TAŞIYICI**
KLP 3259

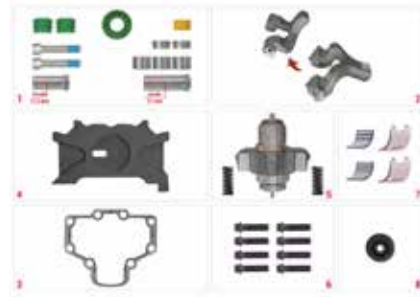

MAXX 17 DORSE SAĞ

**KALİPER
FULL SET**
KLP SET 3021

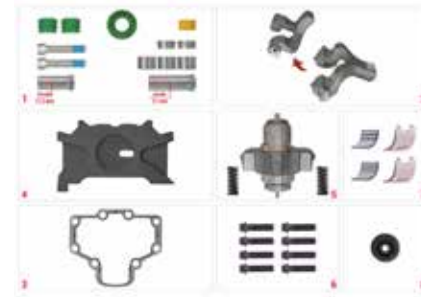

MAXX 17 DORSE SOL

**KALİPER
FULL SET**
KLP SET 3022



MAXX 22 TİP SOL

**KALİPER
TAŞIYICI**
KLP 3264

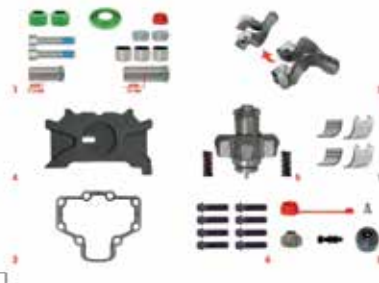

MAXX 17 IVECO SAĞ

**KALİPER
FULL SET**
KLP SET 3023



MAXX 17 IVECO SOL

**KALİPER
FULL SET**
KLP SET 3024

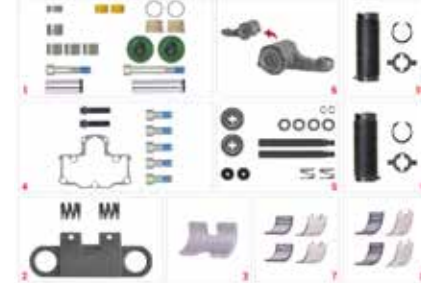

RENAULT MIDLUM 19-2

**KALİPER
FULL SET**
KLP SET 3006



**KALİPER
ŞAPKALI MİL TAKIMI**
KLP 5007



KISA PERNO 36,40x70
UZUN PERNO 37x123
**KALİPER PERNO
BURC TAMİR TAKIMI**
KLP 5003



**KALİPER YARIM AY
RULMAN TAKIMI**
KLP 5005



**KALİPER
RULMAN YATAĞI (KAŞIK)**
KLP 5022



**KALİPER
ELLE AYAR MİLİ**
KLP 5018



**BALATA TUTUCU
SETİ**
KLP 5024



12 TON + RULMANLI KAŞIK
**KOMPLE MEKANİZMA
SETİ**
KLP 5033



RULMAN KAŞIK
KLP 5034



**KALİPER
TAŞIYICI**
KLP 5300



YENİ MODEL SAĞ
**KALİPER
FULL SET**
KLP SET 5005



YENİ MODEL SOL
**KALİPER
FULL SET**
KLP SET 5006



VOLVO - RENAULT

**KALİPER
AYAR TOZ LASTİĞİ**
KLP 2111



PERNO 35x102
VOLVO

**KALİPER PERNO
BURC TAMİR TAKIMI**
KLP 2108



RENAULT 420 - 440
KISA PERNO 35x79
UZUN PERNO 35x132

**KALİPER PERNO BURC
TAMİR TAKIMI**
KLP 2128



KISA PERNO 31x117
UZUN PERNO 35x117

**KALİPER PERNO BURC
TAMİR TAKIMI**
KLP 2247



**KALİPER
RULMAN YATAĞI**
KLP 2140



VOLVO - RENAULT

**KALİPER RULMAN YATAĞI
BİLYA BURC TAKIMI**
KLP 2070



RENAULT 400-420 / 440 VOLVO
KISA PERNO 31x83,50
UZUN PERNO 35x144

**KALİPER PERNO BURC
TAMİR TAKIMI**
KLP 2231



VOLVO
KISA PERNO 35x60
UZUN PERNO 35x102

**KALİPER PERNO
BURC TAMİR TAKIMI**
KLP 2109



**KALİPER
YARIM AY RULMAN TAKIMI**
KLP 2071



VOLVO

**KALİPER
ELLE AYAR MİLİ**
KLP 2188



VOLVO

**KALİPER
ŞAPKA TAMİR TAKIMI**
KLP 2112

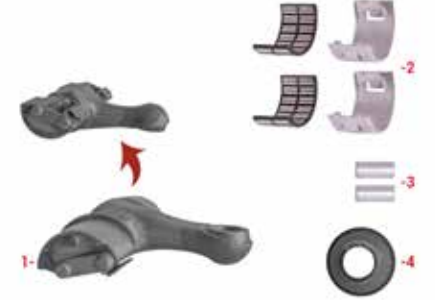

VOLVO ARKA SAĞ

**KALİPER
RULMAN YATAĞI (KAŞIK) R**
KLP 2121



RENAULT 400 - 420

**KALİPER
ELLE AYAR MİLİ L**
KLP 2138



RENAULT 400 - 420

**KALİPER
ELLE AYAR MİLİ R**
KLP 2137



KISA PERNO 30,90x77,50
UZUN PERNO 35x117

**KALİPER PERNO BURC
TAMİR TAKIMI**
KLP 2045



VOLVO ARKA SOL

**KALİPER
RULMAN YATAĞI (KAŞIK) L**
KLP 2120



RADIAL ÖN

**KALİPER
RULMAN YATAĞI (KAŞIK)**
KLP 2122



440 RENAULT - VOLVO - CARGO

**KALİPER
RULMAN YATAĞI (KAŞIK)**
KLP 2039



**KALİPER
AYAR CİVATASI - R**
KLP 2114



**KALİPER
AYAR CİVATASI - L**
KLP 2113



VOLVO ÖN - R - L / ARKA - R
**KALİPER
AYAR MEKANİZMASI - R**
KLP 2118



VOLVO ARKA - L
**KALİPER
AYAR MEKANİZMASI - L**
KLP 2119

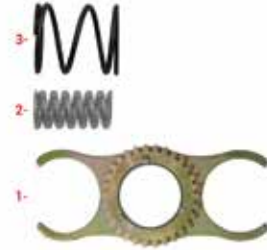

VOLVO
**KALİPER
AYAR DİŞLİ TUTUCU**
KLP 2115



VOLVO YENİ MODEL 2008
SONRASI ÖN
**KALİPER
RULMAN YATAĞI (KAŞIK)**
KLP 2034



RENAULT 420
**KALİPER KAPAK
MEKANİZMA AYAR SETİ**
KLP 2224



RENAULT 440 - CARGO
**KALİPER KAPAK
MEKANİZMA AYAR SETİ**
KLP 2225



**KALİPER AYAR CİVATASI
KİLİT SAÇI**
KLP 2123

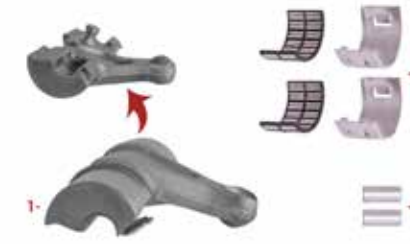

ROR DORSEY
**KALİPER RULMAN
YATAĞI (KAŞIK)**
KLP 2038



RENAULT 440 22,5
KALİPER TAŞIYICI
KLP 2321



VOLVO 22,5
KALİPER TAŞIYICI
KLP 2319



KISA PERNO : 30,90*77,5 ,
UZUN PERNO : 35*117
**KALİPER PERNO BURÇ
TAMİR TAKIMI**
KLP 2063



KISA PERNO : 31*83,5 ,
UZUN PERNO : 35*144
**KALİPER PERNO BURÇ
TAMİR TAKIMI**
KLP 2133



**KALİPER
RULMAN TAKIMI**
KLP 2204



**İPAT
TUTUCU**
KLP 2253



FORD CARGO
**KALİPER
TAŞIYICI**
KLP 2330



40X18
**KALİPER
TAPASI**
KLP 2542



**KALİPER
TOZ LASTİĞİ**
KLP 2582



VOLVO
**KALİPER
FULL SET**
KLP SET 2012



VOLVO
**KALİPER
FULL SET**
KLP SET 2013



123 MM
**KALİPER RULMAN YATAĞI
(KAŞIK)**
KLP 2037



VOLVO ARKA - L
**KALİPER RULMAN YATAĞI
(KAŞIK)**
KLP 2033



MODUL GEN X
**KALİPER PERNO
BURC TAMİR TAKIMI**
KLP 4024



**KALİPER
KOMPLE MEKANİZMA SETİ**
KLP 4035



KISA PERNO 35x118,70
UZUN PERNO 35,50x86,75
MODUL T
**KALİPER PERNO
BURC TAMİR TAKIMI**
KLP 6001



MODUL T
KALİPER SARI TAPA
KLP 6007



KALİPER SİYAH TAPA
KLP 6006



**KALİPER PLASTİK
MEKANİZMA DİŞLİSİ**
KLP 6004



**KALİPER MEKANİZMA
SABİTLEME PLASTİĞİ**
KLP 6010



**KALİPER AYAR SABİTLEME
PLASTİĞİ**
KLP 6002



MODUL T
**KALİPER PLASTİK
DİŞLİ TAPA TK.**
KLP 6026



**KALİPER MEKANİZMA
KOMPLE SET**
RH 6017



**MODUL T
KALİPER BALATA
TUTUCU LEVYE TAKIMI**
RH 6019



**SAF TİPİ
KALİPER
AYAR TAŞIYICI**
KLP 6022



**FORD CARGO
AYAR CİVATASI**
EF 101



**FORD CARGO
TOZ LASTİK SİLİKON**
EF 110



**FORD CARGO
TAHRİK BURCU**
EF 144



**FORD CARGO
BASKI KELEPÇESİ**
EF 226



**FORD CARGO
YAYLI AYAR MANDALI**
EF 401



**FORD CARGO
KORUK KAMASI**
EF 403



**FORD CARGO
KORUK KAMASI**
EF 423



**PRO 522
KORUK KAMASI**
EF 527



**PRO 522
TOZ LASTİK SİLİKON**
EF 531



BMC 522

FREN AYAR SETİ

EF 535



**AYAR MEKANİZMA
SAĞ D001**

RH 680.00



**AYAR MEKANİZMA
SOL D002**

RH 681.00



ÇAPRAZ MİL DİŞLİ

RH 684.00



**ELLE AYAR
ÇUBUK**

RH 685.00



**AYAR KİLİTLEME SACI
SAĞ**

RH 686.00



**AYAR KİLİTLEME SACI
SOL**

RH 687.00



**BMC PRO
PİNYON DİŞLİ
SAĞ**

RH 688.00



**BMC PRO
PİNYON DİŞLİ
SOL**

RH 689.00



**AYAR ALÜMİNYUM TOZ
KAPAK**

RH 690.00



**SAKS FREN
İTİCİ PİM**

RH 691.00



**SAKS FREN
TUTUCU PİM**

RH 692.00



C YAY

RH 693.00



MANTAR CONTA

RH 694.00



İNCE DİŞLİ

DİŞLİ KAPAK

RH 695.00



TOZ LASTİK SİLİKON

RH 696.00



MERCEDES ARKA

YAY 1237

81976100115 - 3469930310 - 3469930110



MERCEDES ÖN

YAY 1238

3469930210 - 81976100317
81976100118 - 6179930610



JUMBO DORSE

YAY 1240

0 539746120



BMC FATİH - FORD CARGO

YAY 1239

EF 124



TIRSAN UZUN YAY 29 CM

YAY 1279



TIRSAN SERTEL YAY 27 CM

YAY 1320



KOL YAYI UZUN

YAY 1252

0539726030 - 1447003700



KOL YAYI ORTA (STANDART)

YAY 1256



KOL YAYI KISA

YAY 1304



BP DORSE (VABİS) BÜYÜK

YAY 1302

0539746070

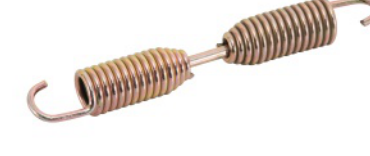

DORSE CİVATALI

YAY 1259

1279502



BP ÇATAL DÜZ YAY
BP ÇATAL ÇENGELLİ YAY

YAY 1298



MERCEDES AXOR Y.M. ARKA

ABS ÇEMBERİ SAC
AC 001

Referans No: 942 356 07 15



MERCEDES ON E.M.

ABS ÇEMBERİ SAC
AC 002

Referans No: 9423340015



MERCEDES AXOR Y.M. ON

ABS ÇEMBERİ SAC
AC 003

Referans No: 943 334 01 15



FORD CARGO ARKA

ABS ÇEMBERİ
AC 010



FORD CARGO ÖN

ABS ÇEMBERİ
AC 011



FORD CARGO ARKA Y.M.

ABS ÇEMBERİ
AC 014



SAF

ABS ÇEMBERİ SAC
AC 004

Referans No: 94029106300



DAF ARKA

ABS ÇEMBERİ SAC
AC 005

Referans No: 1805823 - 1391517



DAF ARKA

ABS ÇEMBERİ SAC KONİK
AC 006

Referans No: 1805824 - 1657638



SAF 88

ABS ÇEMBERİ
AC 015



BP YENİ MODEL

ABS ÇEMBERİ
AC 016



ATEGO ARKA

ABS ÇEMBERİ
AC 017



BPW

ABS ÇEMBERİ SAC
AC 007

Referans No: 331008510



BPW

ABS ÇEMBERİ DOKUM
AC 008

Referans No: 331008510



VOLVO - RENAULT ARKA

ABS ÇEMBERİ DOKUM
AC 009

Referans No: 20424109



DAF ÖN

ABS ÇEMBERİ
AC 020

Referans No: 1805821



SCANIA 4 - G - R SERİ

ABS ÇEMBERİ
AC 021

Referans No: 1442300



MERCEDES ATEGO

ABS ÇEMBERİ
AC 022

Referans No: 9723340115



MRECEDES ARKA E.M.

ABS ÇEMBERİ
AC 023

Referans No: 9423560715



MERCEDES ATEGO ARKA Y.M.

ABS ÇEMBERİ
AC 024

Referans No: 9733561015



SAF

DS 001

Referans No: BÜYÜK MODEL SAĞ



SAF

DS 002

Referans No: KÜÇÜK MODEL SAĞ



SAF

DS 003

Referans No: BÜYÜK MODEL SOL



SAF

DS 004

Referans No: KÜÇÜK MODEL SOL



BPW

DS 005

Referans No: ESKİ MODEL



BPW

DS 006

Referans No: YENİ MODEL



AXL

DS 007



SERTEL 12 TON

DS 008



OZKOC

DS 009



PIRLANTA 12 TON

DS 010



AYDIN

DS 011



BP

DS 012

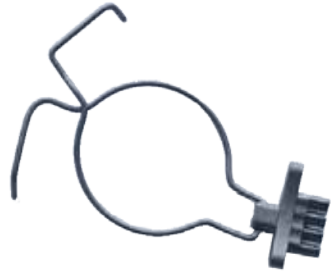

BP

DS 013



BÜYÜK

DS 014



KÜÇÜK

DS 015



BPW 125X2

PORYA KAPAĞI İÇTEN DİŞLİ

PK 006

Referans No: 03.212.24.25.0



BPW 135X2

PORYA KAPAĞI İÇTEN DİŞLİ

PK 007

Referans No: 03.212.25.08.0



BPW 136x2,5

PORYA KAPAĞI İÇTEN DİŞLİ

PK 008



TRAX YENİ MODEL

PORYA KAPAĞI

PK 012



SAF 131X37,5

PORYA KAPAĞI

PK 014

Referans No: 4 304 0093 00



SAF 151,3X52

PORYA KAPAĞI

PK 015

Referans No: 4 304 0102 00
4 304 0102 01 - 3 304 0102 01



AXL 136X2

PORYA KAPAĞI

PK 021

Referans No:



AXL 140X2

PORYA KAPAĞI

PK 022

Referans No:



SERTEL 143X2

PORYA KAPAĞI

PK 024

Referans No:

auto brake

Bertocco

HAKKIMIZDA

“ 1986 yılında İzmir’de kurulan firmamız, sektördeki 37 yıllık deneyimi ile Treyler, Otobüs, Kamyon ve Tır fren sistemleri için yedek parça satışı yapmaktadır. Yurtiçinde ve dışında fren sistemleri üzerine üretim yapan konusunda lider firmaların bayiliğini yapmakta ve ayrıca kendi markaları altında üretim yaptırmaktadır.

37 yılı aşkın süredir sektörde devamlılığı sağlayan, tecrübesi ve bilgi birikimi ile fren sistemleri konusunda müşterileri için iyi bir tedarikçi olmanın gayreti içerisindeyiz.

Hedefimiz, Sürekli değişim halinde bulunan fren sistemleri sektöründe, ürün yelpazemizi, kalitemizi ve hizmetlerimizi geliştirerek müşterilerimiz için iyi bir çözüm ortağı olabilmektir. ”

ABOUT US

“ Our company was founded in 1986 in İzmir. We sell spare parts for Truck, Bus, Trailer and Semi-trailer with 37-years experience. We are authorized distributor for some well-known brand manufacturers for air brake system and distribute products manufactured under own registered brand - names.

We are in an endeavour being a supplier for our customers about air brake system with experience, knowledge and continuity throughout 37 years.

Our main goal is to be best partner for our customers and develop our product range, quality and services in the everchanging and ever-growing air brake system technology. ”

ÜRÜN GARANTİ ŞARTLARI

OCAK 2023

Ürünlerimiz ‘üretim hatalarına’ karşı **1 ay** süre ile garantilidir.

Garanti şartları aşağıdaki durumlarda geçersizdir:

1. 2 YIL ve daha eski ürünler. Ürünün üretim tarihi, metal etikette yazılıdır.
2. Araç hava tertibatında bulunan kurum, çamur, yağ, toz vs gibi maddelerin ürün içerisine girmesi
3. Uzun zaman kullanıldığını gösteren küflü ve paslı ürünler
4. Ürün portlarında kırılma, çatlama gibi montaj sırasında oluşan hasarlarda
5. Araç ile uyumu olmayan yanlış ürün seçiminde.

Ürün iadesi yapmadan önce gerekli olan, marka kontrolü, yıl kontrolü, yağ ve korozyon kontrolü yapıldıktan sonra iade edilmesini rica ederiz.

Saygılarımızla

auto brake

Bertocco



auto brake

Bertocco

www.autobrake.com.tr

www.autobrake.com.tr

www.autobrake.com.tr



Turkey
Discover
the potential